

LUXURIATE IN FIBERS, FIT, AND FINISHES

Interweave

Knits

Fall 1998

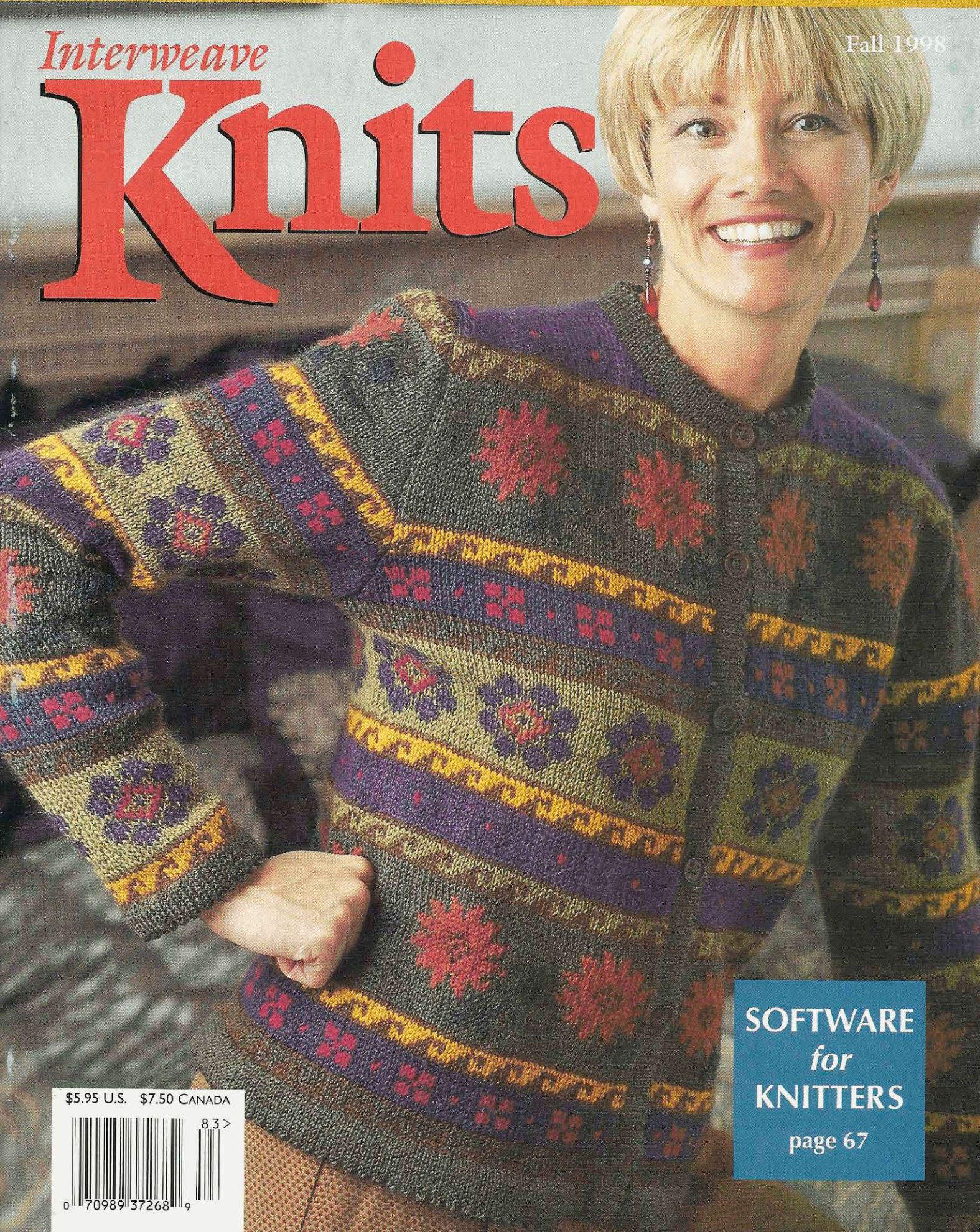

SOFTWARE
for
KNITTERS
page 67

\$5.95 U.S. \$7.50 CANADA



0 70989 37268 9

L'Atelier

SANTA MONICA (310) 394-4665
REDONDO BEACH (800) 833-6133

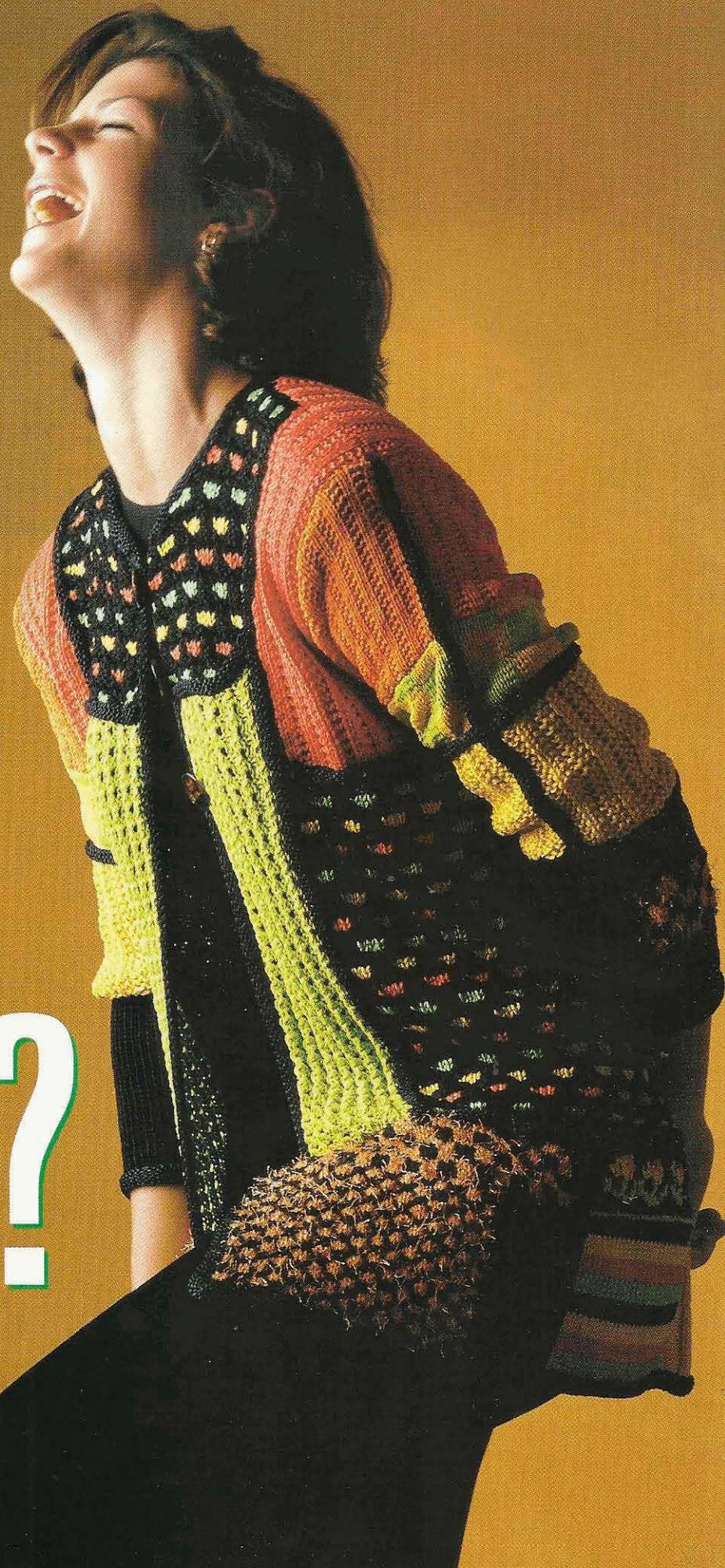

Got
Yarn?

Interweave Knits

FALL 1998
VOLUME III, NUMBER 3

Features & Projects

- 12 **Andean Artistry** NORIKO SEKIGUCHI
- 18 **St. Honoré** BARBARA VENISHNICK
- 24 **Purple Passion Pullover** NICKY EPSTEIN
- 28 **A Natural Flair** BIRGITTA STOLPE
- 32 **Strands of Pearls Pullover** DIANE ZANGL
- 36 **Opposites Attract** JUDITH L. SWARTZ
- 40 **Sideways Seed Jacket** HÉLÈNE RUSH
- 44 **The Elegant Seamen's Scarf** MYRNA A. I. STAHRMAN
- 48 **Handknits by Machine** SUSAN GUAGLIUMI
- 54 **Batter-Up Jacket** BRIDGET ROREM
- 60 **Cradle-to-Couch Blankets** EILEEN MEHL
- 67 **High Tech Knitting:
A look at software for knitters**
TARA JON MANNING
- 72 **Shawl We Dance?** KNITS STAFF
- 80 **Knits Survey**

Strands of Pearls Pullover
page 32



Purple Passion Pullover
page 24



Departments

- 2 **Strands**
FROM THE EDITOR
- 5 **Cables**
LETTERS FROM OUR READERS
- 5 **Oops**
- 6 **Glossary**
- 8 **Beyond the Basics**
LUXURY FIBERS: LAUNDERING, STORING,
AND PROBLEM SOLVING
AMY C. CLARKE
- 52 **Folklore**
LUXURY LUXUS DELUXE
ROBIN HANSEN
- 59 **In the Round**
AN EVENING WITH A CLOSE-KNIT GROUP
NICKY EPSTEIN
- 64 **Connections**
WOOL FESTIVAL AT TAOS
JUDITH DURANT
- 79 **Product News**
JILLIAN MORENO
- 81 **Advertisers' Index**
- 81 **Sources for Supplies**
- 88 **Ravelings**
ICH BIN EIN KNITTING MACHINE
ROBBIE FANNING

STRANDS

LOVE AT FIRST FEEL



I GENERALLY FALL IN LOVE with a yarn first; a design second. I pick up a skein and it's the touch that appeals to me. I walk into a yarn store or stroll into booths at a yarn show and braille my way through. I pick up a seemingly plain ball of yarn and words like "oo" and "ah" escape from my lips as I discover the softness of an extra-fine merino wool. Or if I'm yarn shopping with a friend, I find myself picking up a skein, handing it off to her, and saying, "Doesn't this *feel* good?" Sound familiar?

When I travel I look for ultra-special yarn to bring back as gifts for my knitting friends. I think about what yarn is perfect for them, what yarn leaps off the shelf and says "Buy me." I find myself thinking about my friends in terms of yarns and what would appeal to their tactile nature.

When photographer Joe Coca came back from Peru, he presented me with balls of alpaca yarn. This yarn immediately became a woven scarf that I then gifted to someone else. The one partial ball remaining was recently discovered

by my new kitten as he explored my studio. I laughed when I saw him carrying it in his mouth and wondered if he felt its softness the same way I do or if it was another furry little creature to him.

Focusing on luxury fibers for this issue appealed to my tactile nature. It brought back memories of my clothing and textile teacher from college. She instructed us to "live" with fabric and let it decide what it wants to become—what form,

what drape, what quality does it possess? As I hold yarn in my hand, I find myself asking those same questions.

When I'm considering the designs we receive for the magazine, I have to flip-flop my usual way of working from fiber first, design second. We receive such beautiful submissions that it's always a difficult process to decide. Judith, Ann, and I lay the designs out and spend hours discussing them, choosing our favorites, talking about why and why not. And then we leave work and come back the next day to see if we still feel the same way. In fact, for this issue we left the designs out for several days so we could just "happen" by them and sense whether they were right.

As you flip through this issue, I hope that you can "feel" the yarns and that your fingers will start itching for the luxuriousness of the fibers.

Marilyn Murphy

In the next

Knits

Classics that Never Grow Old

Retro Inspirations

Repair, Reshape, Restore

EDITORIAL

EDITORIAL DIRECTOR Linda Ligon EDITOR Marilyn Murphy ASSOCIATE EDITOR Judith Durant ASSISTANT EDITOR Ann Budd PRODUCTION EDITOR Mona Pompili
TECHNICAL EDITOR Dorothy T. Ratigan EDITORIAL ASSISTANT Amy C. Clarke COPY EDITOR Stephen Beal

PUBLISHING

PUBLISHER Logan Chamberlain MARKETING & SALES DIRECTOR Jillian Moreno BUSINESS & OPERATIONS DIRECTOR Ceri Anderson
ADVERTISING DIRECTOR Suzanne DeAtley ADVERTISING Jan Hogestad, Sharon Altergott CIRCULATION MANAGER Jenny Fish SUBSCRIPTION SERVICE Donna Melton

ART & PRODUCTION

DESIGN Elizabeth R. Mrofka PRODUCTION MANAGER Marc McCoy Owens PRODUCTION COORDINATOR Shelly Leuer PRODUCTION ASSISTANT Andy Webber
ILLUSTRATION Gayle Ford, Susan Strawn Bailey PHOTOGRAPHY Joe Coca PHOTOGRAPHIC ASSISTANT Lisa Rabold

Interweave Knits (ISSN 1088-3622) is published quarterly by Interweave Press, Inc., 201 East Fourth Street, Loveland, Colorado 80537-5655. Phone (970) 669-7672. Fax (970) 667-8317. Application to mail at Periodicals Postage rates is pending at Loveland, CO 80538, and additional mailing offices. Interweave Knits is copyrighted © 1998 by Interweave Press, Inc. All rights reserved. Reproduction in whole or in part is prohibited, except by permission of the publisher. Printed in the USA. For subscription information, call (800) 645-3675. Visit the Interweave Press web site at: <http://www.Interweave.com>.

 INTERWEAVE PRESS

Distributed by  WARNER PUBLISHER SERVICES
A TIME WARNER COMPANY

ROVINGS

Custom Carding and Dyeing of
fine wools and exotic fibres.

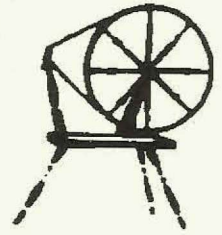

SILKS! ALPACA! ANGORA! KID MOHAIR!

These exotic fibres are blended with Prime
Australian Polwarth wool into 6 luxurious yarns.

42 Gorgeous hand-dyed colours.

We colour match to your specifications.

Polwarth and Polwarth blend yarns—
Hand-dyed or natural colors.

**Price list available upon request.
Sample cards \$10.00**

**Shop Hours: Tuesday - Friday 10:00 - 5:00 (CST)
Saturday 10:00 - 1:00**

**Box 192 Oakbank, MB Canada R0E 1J0
1-800-266-5536
fax: 1-204-444-2245**

**Visa/MC accepted
Prices are in Canadian Dollars**

CABLES

LETTERS FROM OUR READERS

NIHON VOGUE

Could you please send contact information for the Japanese Knitting School mentioned in Patricia Baron's article, "Connections: Knitting in Japan," in the Spring '98 issue? Do you know if they accept foreign students and if any classes are given in English?

—Ninki Mallet
Malibu, California

Patricia Baron very generously answered the many requests for more information about the Nihon Vogue publication and school.

"I am very happy that the article about knitting in Japan inspired other Knits readers. It is my understanding that Nihon Vogue Publications are no longer available in this country due to prior marketing attempts which were unsuccessful. However, some back issues of Keito Dama and other Japanese knitting magazines may be available through Nihon Vogue's former U.S. distributor, Mrs. Yo Furuta at Yo's Needlecraft, 940 E. Dominguez, Suite P, Carson, CA 90746, (310) 515-6473. Southern California readers may also try the Yao Hon Japanese Market in Costa Mesa where Japanese needlework magazines are sold.

"Regarding information on the Nihon Vogue School, interested parties may contact Mr. Tadanobu Seto, Publisher, or Mr. Nubuaki Seto, Editor, at: Nihon Vogue Publications, Tani Moto Son Cho 3-23, Shin Juku Ku Shi, Tokyo To, Japan T 162-91. All correspondence must have proper postage for Japan or may not be delivered. In addition, inquiries should include return postage or a request for a bill for expenses incurred on the part of the publisher."

—Patricia Baron
Rancho Santa Margarita, California

HATS FOR CHEMO PATIENTS

While visiting a friend in a hospital recently, I stopped in the gift shop and noticed a number of machine-knitted cotton hats—alternatives to baseball caps and scarves for patients recovering from chemotherapy. I wonder why knitters haven't thought of this as a charity project. We make hats, mittens, and quilts for the abused, homeless, and less unfortunate, but I've never heard of knitting hats for cancer patients.



I would like to suggest to your readers that they bring this idea to their local guilds or yarn shops. The hats could be distributed to hospitals with radiation and chemotherapy programs.

—Beverly M. Keller
Richfield, Wisconsin

DOMINO DELIGHT

I love every issue of *Knits* and only wish it came out six times a year! Thanks especially for the article on domino shells (Spring '98). I have wanted to find this pattern since seeing it in a shop window two years ago. I plan to start knitting my domino sweater as soon as possible. I'm an experienced knitter and have been looking for a magazine with projects that can challenge me.

—Katherine Smith, North Bay, Ontario

If you want something out of the ordinary, see Noriko Sekiguchi's "Andean Artistry" on page 12, Barbara Venishnick's "St. Honoré" on page 18, or Myrna Stahman's "Seamen's Scarves" on page 44.

MAKING IT FIT

I have just finished knitting the "Cluny Jacket" in the Winter '97 issue. I ran into quite a bit of trouble with the sleeves, which would have turned out too long if I had followed the instructions as I understood them. I'm only 5'3" tall, and the jacket fit like a long coat. I could have given it to one of my daughters but which one? So, out of desperation, I threw the whole thing into the washing machine and felted it. I can't tell you how beautiful it is now; the fit is superb. For the cost of the yarn and a month of knitting like crazy, I have a beautiful Easter outfit.

—Phyllis Orth, Peshtigo, Wisconsin

Good thinking, Phyllis. Where would we be without washing machines?

A MANLY REQUEST

I agree with Wendell Clark (Summer '98, page 3)—a few more "guy" projects would be nice. Some of us women *do* knit for men! Thanks for a great magazine!

—Mary Hazlett, Akron, Ohio

See Bridget Rorem's "Batter-Up Jacket" on page 54 for another project designed specifically for men (though women could wear it just as well!).

SHORT ROW ERROR

The "Beyond the Basics" article on short rowing (page 6) in the Summer '98 issue has much good information. However, in the section "Adding bust fullness", the basic concept is backwards! The fullness needs to be added to the center of the front, not to the sides.

—Janet A. Brodie
Dobbs Ferry, New York

We got lots of letters on this one. As much as we'd like to say we were just checking to see how many of you were paying attention, the fact is, we were wrong. See "OOPS" below for corrected instructions.

We welcome your comments and questions. Write to "Cables", Interweave Knits, 201 East Fourth Street, Loveland, CO 80537-5655; fax (970) 669-6117.

OOPS!

Correction to the Summer '98 issue:

"Intertwining Cables" (page 46): Row 41 of the Cable chart on page 48. None of the cable symbols on this row should be shaded green.

"Beyond the Basics" (pages 7–8) gave incorrect information for adding bust fullness. You should add bust fullness to the center of a garment the same way you add fullness to the tummy. Work three or four sets of short rows, beginning and ending three stitches in from the edges. There will be more rows in the center of the piece but the number of rows at the edges (side seams) will not change.

GLOSSARY

ABBREVIATIONS

alt	alternate
BC	back cross
beg	beginning; begin; begins
bet	between
BO	bind off
CC	contrasting color
cm	centimeter(s)
cn	cable needle
CO	cast on
cont	continue
dec(s)	decrease(s); decreasing
dpn	double-pointed needle(s)
FC	front cross
foll	following
g	gram(s)
inc	increase; increasing
k	knit
k tbl	knit through back of loop
k2tog	knit two stitches together
kwise	knitwise
LC	left cross
LT	left twist
m(s)	marker(s)
MC	main color
mm	millimeter(s)
M1	make one
p	purl
patt(s)	pattern(s)
pm	place marker
psso	pass slip stitch over
p2tog	purl two stitches together
pwise	purlwise
RC	right cross
rem	remaining
rep	repeat
rev St st	reverse stockinette stitch
rib	ribbing
rnd(s)	round(s)
RS	right side
RT	right twist
sc	single crochet
sk	skip
skp	sl 1, k1, psso
sl	slip
sl st	slip stitch (sl 1 st pwise unless otherwise indicated)
ssk	slip, slip, k 2 sl sts tog
st(s)	stitch(es)
St st	stockinette stitch
tbl	through back loop
tog	together
WS	wrong side
wyb	with yarn in back
wyf	with yarn in front
yo	yarn over
*	repeat starting point (i.e., repeat from *)
**	repeat all instructions between asterisks
()	alternate measurements and/or instructions
[]	instructions that are to be worked as a group a specified number of times

Knitting Gauge

To check gauge, cast on 30 to 40 stitches using the recommended needle size. Work in pattern stitch until the piece measures at least 4" (10 cm) from the cast-on edge. Remove the swatch from the needles or bind off loosely, and lay the swatch on a flat surface. Place a ruler over the swatch and count the number of stitches across and number of rows down (including fractions of stitches and rows) in 4" (10 cm). Repeat two or three times on different areas of the swatch to confirm your measurements. If you have more stitches and rows than called for in the instructions, use larger needles; if you have fewer, use smaller needles. Repeat until the gauge is correct.

Reading Charts

Unless otherwise indicated, charts are read from the bottom up. On right-side rows, read charts from right to left. On wrong-side rows, read charts from left to right. When knitting in the round, read chart from right to left for all rows.

Wraps Per Inch

If you substitute or spin a yarn for a project, you can compare the weight of the yarn to the project yarn by wraps per inch. The simplest way to do this is to wrap your yarn around a ruler for one inch and count the number of wraps. If you have more wraps per inch, your yarn is too thin; fewer wraps per inch, your yarn is too thick.

Binding Off Shoulder Stitches Together

Place the front and back shoulder stitches onto two separate needles. Hold them in your left hand with the right sides of the knitting facing together. In your right hand, take another needle and insert the right-hand needle into the first stitch on each of the left-hand needles and knit them as one stitch. Knit the next stitch the same way. You now have two stitches on the right-hand needle. Pass the first stitch over the second stitch. Repeat until only one stitch remains on the right-hand needle. Cut the yarn and pull the tail through the last stitch.

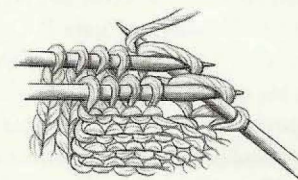

Kitchener Stitch

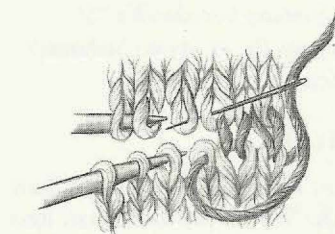

1. Bring yarn needle through the front stitch as if to purl, leaving the stitch on needle.
2. Bring yarn needle through the back stitch as if to knit, leaving the stitch on needle.
3. Bring yarn needle through the same front stitch as if to knit, and then slip this stitch off needle. Bring needle through the next front stitch as if to purl, again leaving the stitch on needle.
4. Bring yarn needle through the first back stitch as if to purl, slip that stitch off, and then bring yarn needle through the next back stitch as if to knit, leaving it on needle. Repeat steps 3 and 4 until no stitches remain.

SSK Decrease (This is a left-slanting decrease.)



figure 1

Slip two stitches knitwise one at a time (figure 1). Insert the point of the left needle into the front of the two slipped stitches and knit them together through the back loop with the right needle (figure 2).

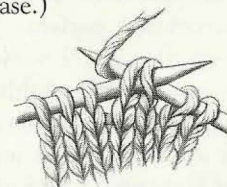
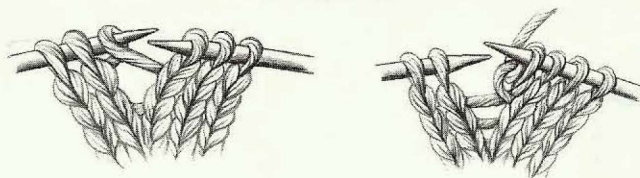

figure 2

M1 Increase



With left needle tip, lift the strand between the last knitted stitch and the first stitch on the left needle, from front to back. Knit the lifted loop through the back.

Single Crochet

Insert the hook into a stitch, yarn over the hook and draw a loop through the stitch (figure 1), yarn over the hook and draw it through both loops on the hook (figure 2).

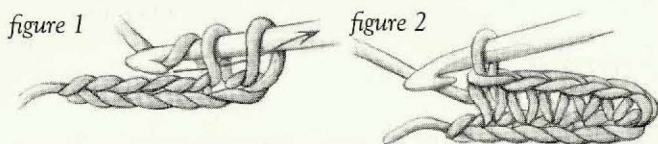

One-Row Buttonhole

Work to where you want the buttonhole to begin, bring the yarn to the front, slip the next stitch purlwise, and then return the yarn to the back.

1. *Slip the next stitch. Then on the right needle, pass the second stitch over the end stitch. Repeat from * 2 (3, 4) times. Slip the last bound-off stitch to the left needle and turn the work.

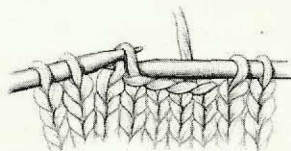

2. Move the yarn to the back and use the cable cast-on to cast on 4 (5, 6) stitches as follows: *Insert the right needle between the first and second stitches on the left needle, draw up a loop, and place it on the left needle. Repeat from * 3 (4, 5) times. Turn the work.

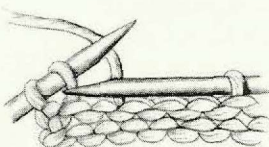

3. With the yarn in back, slip the first stitch from the left needle and pass the extra cast-on stitch over it to close the buttonhole. Work to the end of the row.

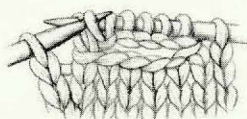

Cable Cast-On



Cast on two stitches using the knitted cast-on method. Insert the right needle between the two stitches on the left needle. Wrap the yarn as if to knit. Draw the yarn through to complete the stitch, but do not drop the stitch from the left needle. Slip the new stitch to the left needle as shown.

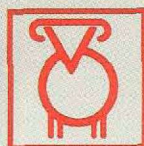

Tahki
Imports Ltd.



Introducing
FARGO
as featured in

textures

Volume 3

To order your copy of Textures, Volume 3, featuring 11 new designs, send a check or money order for \$6.99 to the address below. For the Tahki retailer nearest you, call 201-807-0070. E-mail: Tahki@worldnet.att.net Fax: 201-807-9386 Tahki Yarns 11 Graphic Place, Moonachie, NJ 07074.

BEYOND THE BASICS

Amy C. Clarke



Luxury Fibers: Laundering, Storing, and Problem Solving

AFTER SPENDING HOURS, days, weeks, months, or even years knitting a garment by hand, you'll find that proper care of the finished object is worthwhile. This is especially true for luxury fibers which are usually quite expensive. Knowing some basic facts about individual animals and their fiber will help you make decisions about how to care for your garment.

CHARACTERISTICS OF ANIMAL FIBERS

Produced by animals as protection from the elements in the form of hair, down, and secretions, animal fibers are composed of protein. Fineness in diameter, plus softness, warmth, and limited availability of an individual fiber determine its classification as "luxury". Measured in microns, the diameter, combined with density or lack of scales, decides the softness of a fiber. Warmth is determined by the amount of air trapped by and around the fiber.

Angora (Rabbits)

One of the finest animal fibers, angora is collected from molting Angora rabbits. Characterized by fluffiness, garments made of angora yarn will grow more fluffy with each washing. Because angora has fewer scales than wool, it also has less elasticity and so will need to be shaped and blocked after washing to encourage the garment to hold its shape when dry. After an angora garment has dried completely, it can be fluffed up by putting it through the drier (set on low) for five-minute intervals until the desired fluffiness is achieved.

Chinchilla

While most available products using chinchilla fiber are composed of the animal's pelt, a small amount of chinchilla fiber is collected from the molting fur of this small silver-coated South American rodent. Because one chinchilla molts only about one ounce of fiber in a year, the availability is limited and it is very expensive.

Qiviut (Musk Ox)

Qiviut is the down layer of fiber under the coarse guard hair of the musk ox, a native of Greenland and Northern Canada. Qiviut is about eight times warmer than wool, and because it lacks crimp and scales, it has low elasticity and resists felting. Qiviut is gathered after the musk oxen have molted; the fineness of this fiber, its extreme warmth, and the difficulty in cultivating it make it a luxury fiber.

Silk (Caterpillar secretions)

Silk is the continuous strand of two filaments secreted by the silkworm as it forms a cocoon in preparation for its metamorphosis to a moth. *Bombyx mori* silkworms are cultivated and killed before they break out of the cocoon so that the silk can be unwound from the cocoon in its continuous length—approximately 1,600 yards (1,463 meters).

Camelidae (Camel, Alpaca, Llama)

Camels from Mongolia and Tibet produce an extremely soft and insulating down. Alpacas and llamas are fiber-bearing camelidae that originated in the highlands of South America. Their fiber is very lightweight and has a high degree of insulation suited for the cold, windy climate of the Andes.

Cashmere and Mohair (Goats)

Cashmere is the down produced by goats whose genetics derive from Asian stock, most notably originating in Kashmir, China, Tibet, and Mongolia. Very fine, small amounts are collected off the molting goats each year; one goat will produce less than half a pound of fiber. Produced by the Mohair goat (formerly the Angora goat, whose name was changed by the International Organization for Standardization to avoid confusion with the Angora rabbit), mohair is a very strong hair with high luster.

Fine Wools (Merino and Rambouillet Sheep)

Wool from merino and rambouillet sheep (rambouillet are descended from merino) is characterized by fine diameter fiber, softness, and elasticity. Prone to felting and distorting during the laundering process, merino will shrink as much as 40 to 70 percent.

WASHING ANIMAL FIBERS

Most garments made with animal fibers can be carefully washed by hand. While the animals are vastly different, all their fibers are protein that can be treated similarly when washing, drying, protecting from insects, and storing. Before laundering your handknit garment, launder a small swatch to ensure that the end result is one you want. Use the swatch to determine if the dye is colorfast and to see if the yarn will shrink or distort during laundering.

Water Temperature

Fear of felting keeps many knitters from washing their garments in warm to hot water, although hotter temperatures remove soil. Felting occurs when the scales on a fiber are opened by hot water, moved closer together with the assistance of agitation and soap, then locked down by cold water. Rapid change of temperature combined with agitation causes

felting—if you keep the temperature of the water constant and the movement of the garment minimal, felting is less likely to occur.

Use a work area with two basins or tubs so that you can wash in one tub and rinse in the other. Not only is this convenient, it will also prevent the garment from cooling between rinses.

Heat both wash and rinse water to between 110 and 120°F (43 and 49°C). Hot water will melt the lanolin and grease that naturally occur on some fiber. As you rinse, gradually lower the temperature of the water.

Soaps and Detergents

Composed of the protein keratin, animal fibers will break down if exposed to high amounts of alkalinity (such as are contained in chlorine bleach, washing soda or water softener, and other strong detergents). When laundering animal fibers, it is important to use a soap or detergent that has a neutral pH level. If you have hard water and need to use a water softener, add a little vinegar to the rinse water to neutralize the alkalinity. Your local yarn shop should carry soaps and detergents that are appropriate for luxury fibers. Some specialty detergents use scents that deter moths from eating the fibers. Liquid dishwashing soaps such as Joy and Ivory are also suitable for washing protein fibers.

Support Wet Garments

While most vegetable fibers (such as cotton and linen) gain strength when wet, animal fibers lose strength—some as much as 25 percent. For this reason, and because of the added weight of the water, support a delicate garment as you lift it in and out of the tubs. Enclose the garment in an open-weave laundry bag, or place it in a colander or other container that will support it while permitting the dirty water to escape.

Centrifugal Force to Extract Water

While the laundering action of a normal washer will felt most animal fibers, the spin cycle can extract excess water without distorting or felting the garment. Put the wet garment in an open-weave laundry bag in the washer. Balance the load with a wet towel or another wet garment and set the washer to the spin cycle. Make sure the machine is set so that no water will be added during the cycle. The centrifugal force of the spinning washer will extract the water in only a few minutes. If you don't have access to a washer with a spin cycle, gently squeeze out excess water without twisting or wringing the garment and then roll it in towels until it is just damp.

Blocking and Drying

Lay the wet garment on a cotton towel that will absorb water and help the garment dry more quickly. Block the garment by pinning it out to its proper shape. Make sure seams are straight and the rows of knitting are aligned and parallel. The garment will hold the blocked shape until it is wet again. Keep the garment out of direct sunlight to prevent loss of color and damage to the fiber which can become brittle with prolonged light exposure.

BERROCO®

Build your fall knit wardrobe around SensuWool™. It's dyed to match Chinchilla and Glace and featured in Brochure #176.



WARDROBE

Free **YES. Send me Berroco's Fall Winter '98-99 Update.** (US residents only)

Featuring sweaters, skirts, jackets, coats, dresses and accessories for your wardrobe and home. If you are a subscriber there is no need to respond. You will automatically receive our Fall issue.

Name _____

Address _____

City _____ State _____ Zip _____

Mail to: Berroco Inc.,
Dept. IF98,
P.O. Box 367, Uxbridge, MA 01569-0367



Woolen Yarns

Pure wool yarns in a variety of weights and colors for knitting and weaving.

Carded wool in natural and dyed colors for handspinning and felting.

Custom carding, spinning and dyeing available.

Send \$4.00 for knitting yarn samples. Dealers inquiries invited.

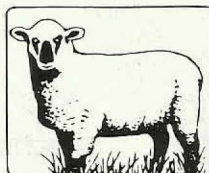

WILDE YARNS®

PO Box 4662, Dept. I
Philadelphia, PA 19127-0662
Spinning Wool Since 1880.

addi Turbo® needles

the choice of professional knitters

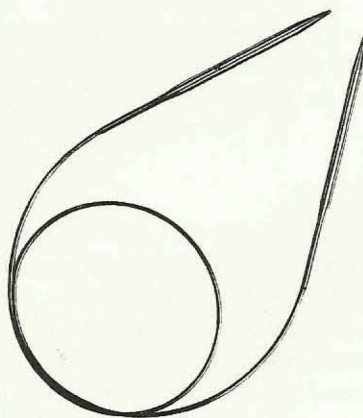

Slick tips, smooth joints and pliable cords have made the addi Turbo® circular needle the choice for professional knitters for years! Isn't it time you joined them?

Available in 8 lengths from 12" to 60" and in 19 sizes ranging from a US 000 to a US 36.

available in fine yarn shops

Exclusive Distributor

skacel collection, Inc.

PO Box 88110, Seattle, WA 98138-2110

Phone: (253) 854-2710

Fax: (253) 854-2571



A DIFFERENT NORWAY



Introducing GARNSTUDIO yarns
Fabulous Fibers • Great Colors • Inspiring Patterns

For dealer information, please contact:

AURORA YARNS

P O Box 3068 • Moss Beach CA 94038

tel: 650-728-2730 • fax: 650-728-8539

e-mail: aurorayarns@pacbell.net

The Enchanted Jacket

Perfect for every occasion.

Since the bodice falls freely from the bust, the style is flattering on a wide variety of body types from size 6 to size 22.

Available at your local yarn shop or call:
1-800-607-2462



- Made from Douceur et Soie, a luxury fiber of 70% baby mohair and 30% silk
- Perfect for proms, parties and weddings
- Light as a feather and fun to knit on size 5 needles

K'C₂ Solutions
Crafts, Sewing, Needlework

2220 EASTMAN AVENUE, #105 • VENTURA, CA 93003

STORING LUXURY-FIBER GARMENTS

Store garments so that there are no stress points, either through hanging or folding. Lay flat in a drawer with sheeting or tissue paper separating each layer. Rolling thin garments on tubes is a good way to prevent the damage caused by storing a folded garment over a long time. Avoid storing any fiber in plastic bags, as resulting condensation can cause mildew.

PREVENTING MOTH INFESTATION

Storing fibers in a tightly sealed wooden drawer or chest containing moth repellent will prevent infestation of insects and rodents. If you find that an unprotected garment has been damaged by insects, take it outside—light and air will cause the insects to fall out of the garment. Pick out as many bugs as you can by hand, then place the garment in a zippered plastic bag and store in the freezer for a couple of days to kill any remaining insects or eggs. Wash the garment with a wool-safe detergent that contains an “anti-feedant” scent (a scent that deters the insects from feeding) and store

with moth repellents. While moth balls will kill insects, they may also be carcinogenic. Herbal alternatives to moth balls such as essential oils and herb sachets are discussed at length in Rita Buchanan’s *Spin-Off* article (Summer 1996), “Herbal Moth Repellents: Safeguard or Sentiment?”

PROBLEM SOLVING

Pilling occurs when friction and agitation cause short fibers to work to the surface of a garment, ball up, and become slightly felted. While pilling does not affect the strength of the garment, it is unsightly. Pick pills off by hand, not with a “fuzz” remover which can cut the yarn.

Static can be reduced by adding moisture to the garment. Spraying the garment with a fine mist will help remove static and make the garment more comfortable to wear. ∞

Amy Clarke spent many enjoyable hours in the Colorado State University Art Department's dye room washing and dyeing fleece and yarn while she worked on her M.F.A. in Fibers. She is now happily employed as the editorial assistant to craft publications and events at Interweave Press.

RESOURCES

- Buchanan, Rita. “Herbal Moth Repellents: Safeguard or Sentiment?” *Spin-Off* Summer 1996, pp. 25–28.
- Fournier, Jane. “Fiber Basics: Camel: Soft Down, Sturdy Hair.” *Spin-Off* Fall 1994, pp. 36–38.
- Kolander, Cheryl. *A Silk Worker's Notebook*. Loveland, Colorado: Interweave Press, 1985.
- Lynne, Erica. *Angora: A Handbook for Spinners*. Loveland, Colorado: Interweave Press, 1992.
- Meech, Sue. *Cashmere: A Complete Guide from Fibre to Fashion*. Napanee, Ontario, Canada: Sandy Pine Press, 1996.
- Raven, Lee. “Another Look at Wool Scouring: Ingredients, Problems, and Techniques.” *Spin-Off* Winter 1985, pp. 25–28.
- Sparks, Kathy. *Song of the Musk Ox*. Unionville, Indiana: The Hand Maiden, 1993.
- Stove, Margaret. *Handspinning, Dyeing, and Working with Merino and Superfine Wools*. Loveland, Colorado: Interweave Press, 1991.
- Switzer, Chris. *Spinning Llama and Alpaca*. Estes Park, Colorado: Switzerland Enterprises, 1994.
- Wakefield, Danna. “The Musk Ox.” *Spin-Off* Spring 1983, pp. 16–19.



YARNS INTERNATIONAL

Your source for ALICE STARMORE yarns presents Alice's new book

TUDOR ROSES

“The designs in this sumptuous collection reflect the fact that the Tudors wore the most lavish costumes in British history. The craftsmanship of the Tudor tailors and embroiderers...was consummate and Alice Starmore imbues each of her designs with this spirit of the age.” *Tudor Roses*, through both the historical discussion of the period and its translation into the designs themselves, illustrates those qualities that have made Alice “the world’s most innovative and technically accomplished designer of hand knitwear.”



Special Edition Hardcover \$32.95
or Softcover \$23.95 (plus \$2 shipping)

Price includes \$5 coupon
applicable to first yarn purchase.

5110 Ridgefield Rd, Suite 200
Bethesda, MD 20816 • (301) 913-2980



To Order: 1-800 YARNS 2U • 1-800-927-6728



ANDEAN ARTISTRY

NORIKO SEKIGUCHI

Intarsia and Fair Isle

Picot edges

FINISHED SIZE 37½ (41, 43, 46)" (95 [104, 109, 117] cm) bust/chest circumference, buttoned. Sweater shown measures 41" (95 cm).

YARN Dale of Norway Heilo (100% wool; 100 m [91 yd]/50 g): #8972 loden (MC), 5 (6, 6, 6) balls; #5962 midnight blue, 2 balls; #2537 gold, #3727 rust, 1 (1, 1, 2) ball(s) each; #4246 burgundy, #7382 deep green, 1 ball each. Tiur (60% mohair, 40% wool; 126 yd [115 m]/50 g): #3872 chocolate, 2 (3, 3, 3) balls; #9853 olive, 2 (2, 2, 3) balls; #5172 purple, 2 balls.

NEEDLES Hems—Size 3 (3.25 mm): straight, 24" (60 cm), and 29" (80 cm) circular (cir). Body and Sleeves—Size 4 (3.5 mm): straight and double-pointed (dpn). Adjust needle sizes if necessary to obtain the correct gauge.

NOTIONS Markers (m); stitch holders; tapestry needle; bobbins; six ⅝" (1.5 cm) buttons.

GAUGE 24 sts and 28 rows = 4" (10 cm) in color pattern on larger needles; 22 sts and 30 rows = 4" (10 cm) in St st with one color.



Dale of Norway Heilo
4-ply; 13 wraps per inch

THIS CARDIGAN is inspired by Andean and Peruvian knitting and textiles. The slightly hairy mohair-blend yarn has a sheen and luxurious feel. Both color stranding and intarsia are used for the color patterning, and duplicate stitch is used for the flower centers. Set-in sleeves and angled shoulders shaped by short rows give it a fitted look. The neck, sleeves, front opening, and lower body are edged with a picot stitch and hemmed.

To keep the flowers in visual balance, the starting points on the chart vary for the different sizes.

•**Back:** With MC and smaller needles, CO 113 (123, 129, 139) sts. Work 8 (8, 10, 10) rows St st for facing. *Picot row:* K1 *k2tog, yo; rep from *, end k2. Work 9 (9, 11, 11) rows St st, ending with a WS row. Change to larger needles and work chart (beg and end as indicated by color bars for your size) through Row 84, then work Rows 1–6—piece should measure about 13¾ (13¾, 14¼, 14¼)" (35 [35, 36, 36] cm) from picot row. **Shape armholes:** Cont in patt, BO 2 (3, 3, 3) sts at beg of next 2 rows. Then dec 1 st each edge every row 2 (2, 2, 4) times, then dec 1 st each edge every other row 4 times—97 (105, 111, 117) sts rem. Cont in patt through Row 58 (58, 64, 64) of chart, omitting partial flowers on second repeat of Rows 22–44 (and Rows 66–72 for largest 2 sizes) of chart—armhole should measure about 7¾ (7¾, 8½, 8½)" (19.5 [19.5, 21.5, 21.5] cm). **Shape shoulders and neck:** Work in patt across 33 (36, 36, 37) sts, place rem sts on holder. *Right shoulder:* (Worked in short rows; see box on page 15.) Work 1 row. (RS) Work 23 (25, 25, 26) right shoulder sts, wrap st, turn, and work back to end of row. BO 3 sts at beg of next row, work 10 (11, 11, 11) sts, wrap st, turn, and work to end of row. Work 1 row even, working the wraps tog with the wrap sts. Place rem 30 (33, 33, 34) sts on holder. *Left shoulder:* Join new yarn and BO 31 (33, 39, 43) sts for back neck. Work as for right shoulder, reversing shaping.

•**Left Front:** With MC and smaller needles, CO 55 (59, 63, 65) sts. Work 8 (8, 10, 10) rows St st for facing. *Picot row:* K1, *k2tog, yo; rep from *, end

k2. Work 9 (9, 11, 11) rows St st, dec 1 (1, 1, 0) st on the last row (WS)—54 (58, 62, 65) sts rem. Change to larger needles and work chart (beg and end as indicated) until piece measures same length as back to armhole, ending with Row 6 of chart. **Shape armhole:** BO 2 (3, 3, 3) sts at beg of next row. Then dec 1 st at armhole edge every row 2 (2, 2, 4) times, then dec 1 st every other row 4 times—46 (49, 53, 54) sts rem. Cont in patt through Row 49 of chart. **Shape neck:** BO 10 (10, 11, 11) sts at beg of next row. Then dec 1 st at neck edge every row 4 (4, 6, 6) times, then dec 1 st at neck edge every other row 2 (2, 3, 3) times—30 (33, 33, 34) sts rem. Work through Row 58 (58, 64, 64) of chart. **Shape shoulder:** (Worked in short rows; hide wraps over knit sts) Work 20 (22, 22, 23) sts, turn, and work back to end of row. Work 10 (11, 11, 11) sts, turn, and work to end of row. Place sts on holder.

•**Right Front:** Work as for left front, reversing shaping.

•**Sleeves:** With MC and smaller needles, CO 53 (53, 55, 57) sts. Work 6 (6, 8, 8) rows St st for facing. *Picot row:* K1, *k2tog, yo; rep from *, end k2. Work 6 (6, 8, 8) rows St st, ending with a RS row. Change to larger needles and beg on Row 60, follow chart for sleeves (outlined by dotted line) through Row 84, then work Rows 1–84 and then Rows 1–6, and *at the same time*, inc 1 st each end of needle every 8 (8, 6, 6) rows 6 (3, 16, 14) times, then every 6 (6, 4, 4) rows 10 (14, 3, 6) times, working new sts in patt—85 (87, 93, 97) sts; piece should measure about 17½ (17½, 17¾, 17¾)" (44.5 [44.5, 45, 45] cm) from picot row. **Shape cap:** BO 2 sts at beg of next 2 rows. Then dec 1 st each end of needle every row 15 (16, 18, 20) times, dec 1 st each end of needle every other row 10 (10, 8, 6) times, dec 1 st each end of needle every row 8 (7, 9, 11) times—15 (17, 19, 19) sts rem. BO all sts.

•**Finishing:** Block all pieces. BO shoulder sts tog (see Glossary, page 6). With yarn threaded on a tapestry needle, sew side seams. With specified yarns threaded on a tapestry needle, work duplicate stitch on flower centers as



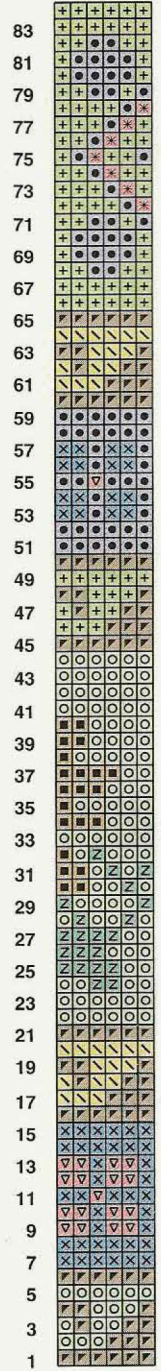
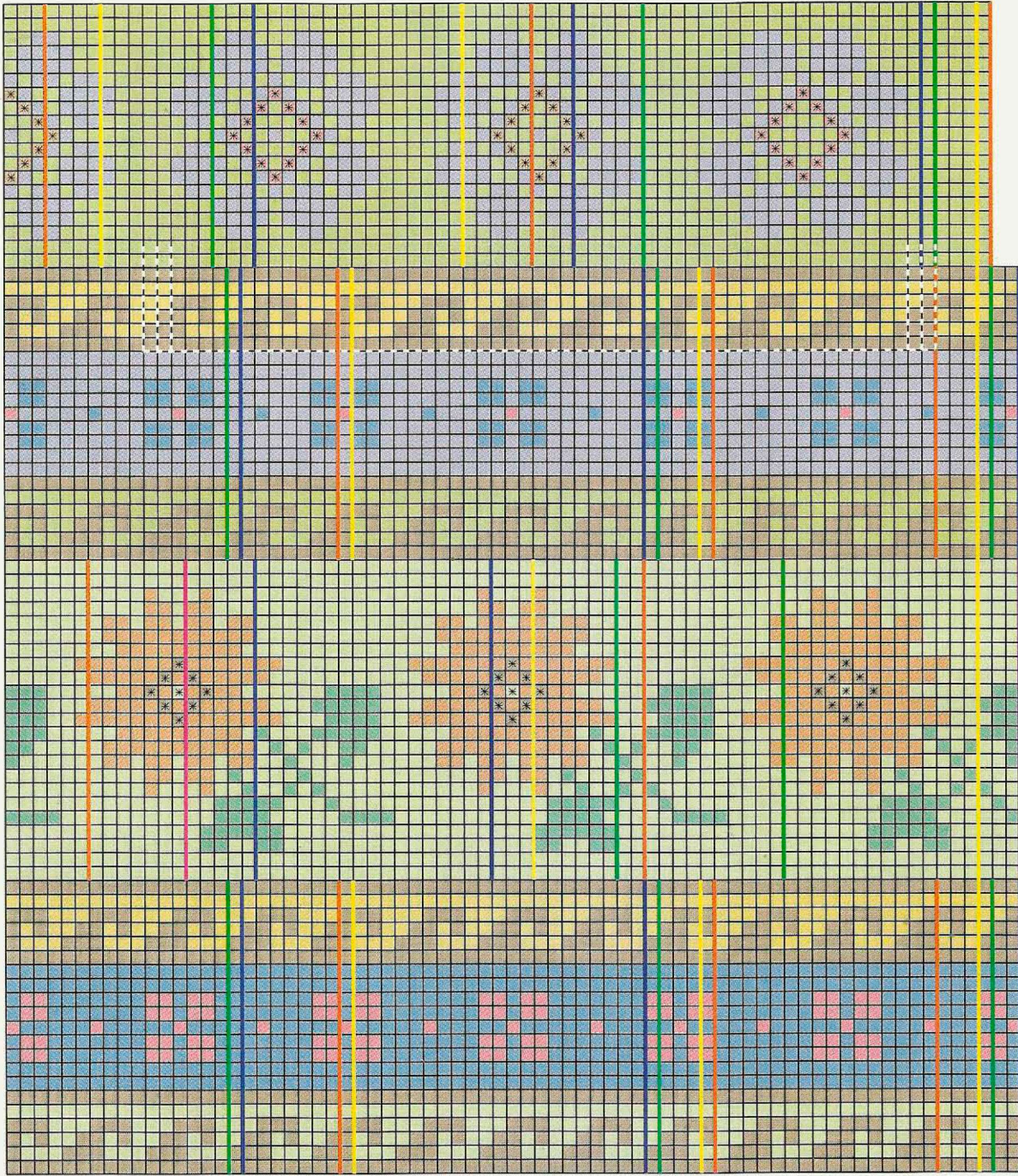

Beg left front

Beg back

Beg right front

- | | | | | | |
|--|-----------------------------------------|--|-----------|--|-----------------|
| | duplicate stitch with appropriate color | | purple | | large |
| | midnight blue | | gold | | x-large |
| | burgundy | | rust | | small & x-large |
| | ioden | | chocolate | | medium & large |
| | olive | | small | | Beg sleeves |
| | deep green | | medium | | |

Work duplicate stitches as follows (beg at right front): For size small: Work (burgundy, rust) 5 times, end with burgundy (11 flowers). For size medium: Work (burgundy, rust) 3 times, then (rust, burgundy) 3 times (12 flowers). For size large: Work (burgundy, rust) 6 times, end with burgundy (13 flowers). For size extra-large: Work (burgundy, rust) 3 times, work burgundy 2 times, then (rust, burgundy) 3 times (14 flowers).

Short Rows

Short rows allow a knitted piece to be shaped without increasing, decreasing, or binding off, and they don't form holes. Short rows are made by knitting only part of a row, slipping a stitch, wrapping it, then slipping it back to the left needle, and turning the piece to work back on the other side. This procedure adds two extra rows to the worked stitches. The turning points in short rows must be staggered or worked between full rows.

Work short rows as follows:

Step 1: Work to turn point, slip next stitch purlwise to right needle. Bring yarn to front.

Step 2: Slip the same stitch back to the left needle (wrapped stitch).

Turn work and bring yarn in position for next stitch.

Note: Hide the wraps in a knit st when the right side of the piece is worked in a knit st. Leave the wrap if the purl st shows on the right side. Hide the wrapped sts as follows: *Knit st:* On RS, work to just before the wrapped st. Insert the right needle on the front under the wrap from the bottom up and then into the wrapped stitch as usual. Knit them together, making sure that the new stitch comes out under the wrap. *Purl stitch:* On WS, work to just before the wrapped st. Insert the right needle from the back under the wrap from the bottom up and put it on the left needle. Purl them together.



Step 1



Step 2

charted. Fold facings to WS along picot row and sew in place. Sew sleeve seams. Sew sleeves into armholes, matching color bands with body. **Button band:** With MC, longer cir needle, and RS facing, pick up and knit 113 (113, 115, 115) sts along left front edge. Work 8 (8, 10, 10) rows St st. *Picot row:* K1, *k2tog, yo; rep from *, end k2. Work 7 (7, 9, 9) rows St st for facing. BO all sts. Fold band to WS along picot row and sew in place. Mark placement of 5 buttons, one 2" (5 cm) from lower edge, one 2¾" (7 cm) from neck edge, and the others evenly spaced in between. **Buttonhole band:** With MC, longer cir needle, and RS facing, pick up and knit 113 (113, 115, 115) sts along right front edge. Work 4 rows St st. On next row, work five 2-st 1-row buttonholes (see Glossary, page 7) opposite markers. Work 3 more rows St st. *Picot row:* K1, *k2tog, yo; rep from *, end k2. Work 7 rows St st for facing, working 5 buttonholes as before on 4th row. BO all sts. Fold band to WS along picot row and sew in place. With MC, stitch around buttonholes, working both layers tog. **Neckband:** With MC, shorter cir needle,

BOOK 100

DALE OF NORWAY®

The Perfect Blend of Inspiration and Quality in Natural Fibers.

Introducing five exciting design books, including the Norwegian National Ski Team and U.S. Olympic Team Collection Designs, featuring Heilo, Falk, Tiur, Free Style and Baby Wool.

Call for your nearest store and our free brochure:
800-441-DALE

RS facing, and beg at right front neck, pick up and knit 31 (31, 34, 35) sts to shoulder seam, 45 (45, 57, 59) sts across back neck, and 31 (31, 34, 35) sts from left shoulder seam to left front neck—107 (107, 125, 129) sts. Work 1 row St st. On next row (RS), k3, work buttonhole as before, knit to end. Work 5 more rows

St st. Picot row: K1, *k2tog, yo; rep from *, end k2. Work 3 rows St st. On the next row (RS), k3, work buttonhole as before, knit to end. Work 3 more rows St st. BO all sts. Fold band to WS along picot row and sew in place. With MC, stitch around buttonhole as before. Sew buttons to button band. Weave in loose end. ∞

Born and raised in Tokyo, Noriko Sekiguchi learned to knit from her mother at age eleven. She later re-discovered knitting and spent three years studying with Miyuki Kumagai, a prominent Japanese designer. She moved to Brooklyn, New York, three years ago where she now lives with her husband. She loves designing sweaters with colors, especially those inspired by ethnic dress and textiles.

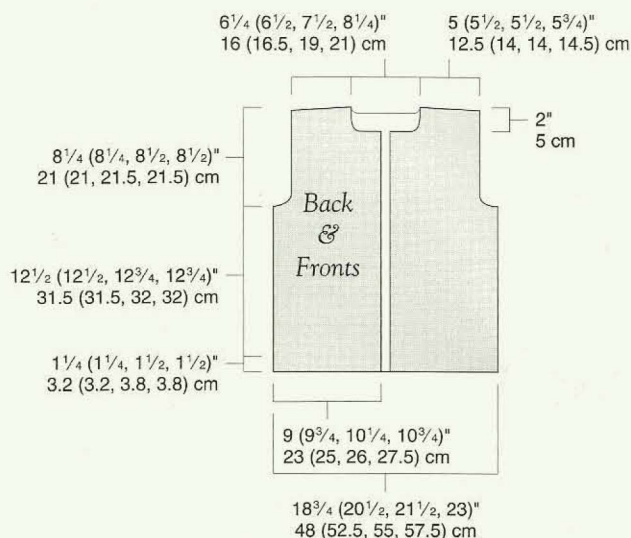
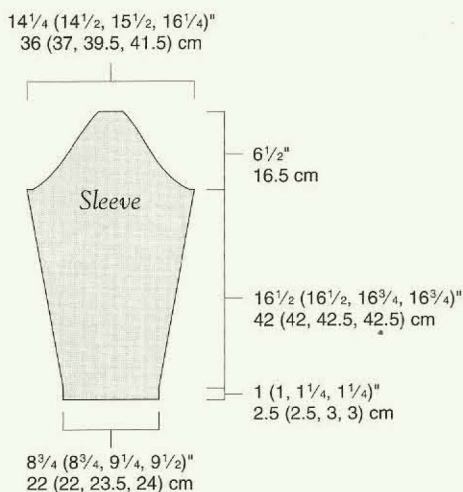

Soft, Warm, Wonderful Llama

Pocket Scarf Kit-to-Knit

Hand-sized pockets at just the right height will keep your hands cozy and warm!

Unique scarf is rib knit for 60" (plus fringe!) in 100% Llama plied with British Mohair Yarn. Llama motif is 100% Llama.

Yarn and Pattern Kit-to-Knit \$49.95 postage paid



Natural white, gray, black, smoke, taupe, navy, purple, forest green, hot pink, red, soft rose, lilac, dusty blue, royal blue with black

100% Llama Plied with British Mohair Yarn

3-4 st/in 55 yards/approx 50g
\$8.95 postage paid

100% LLAMA YARN

4.5 to 5.5 st/in 75 yd/approx 50g
\$9.95 postage paid

Natural white, gray, charcoal, black, fawn, brown, purple, pink, sky blue, medium blue, navy, green, forest green, red, raspberry turquoise, yellow, orange

Catalog with samples

\$5 refundable with order

Llamas and Their Wool

Brochure \$1+SASE

STONE FOX FIBRE WORKS

1544 East River Rd.
(414) 315-2719

Grafton, Wisconsin 53024
stonefox@execpc.com

complete online catalog at www.impossibledream.com/fiber/

Duplicate Stitch

Bring the needle through to the right side at the base of a stitch. Pass the needle under both threads at the base of the next stitch immediately above.

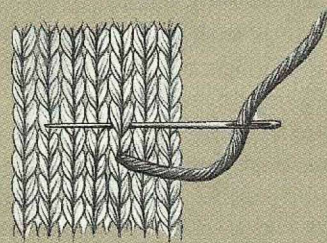

Take the needle through to the wrong side at the base of the first stitch and out at the base of the next stitch to be worked.

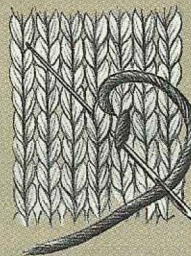

Completed duplicate stitches.

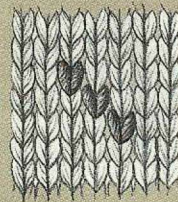

SHUTTLES,



Weaving • Basketry • Spinning
Knitting • Classes

Mon 12-6pm • Tues-Sat 10-6pm
Closed Sundays

633 S. Broadway, Table Mesa Center
Boulder, Colorado

(303) 494-1071 • (800) 283-4163

SPINDLES & SKEINS

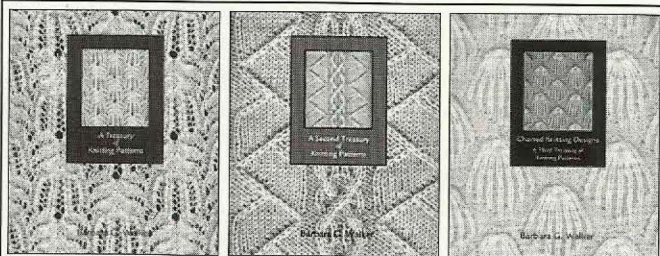

Barbara G. Walker

- *A Treasury of Knitting Patterns*
- *A Second Treasury of Knitting Patterns*
- *Charted Knitting Designs, a 3rd Treasury*

This classic and indispensable stitch-pattern trilogy is back in print. Each book contains many hundreds of designs - all photographed - plus valuable knitting tips from the author, a treasure herself.

pb \$30 each. Postage \$5 for one or for all.

Add \$5 for a catalog of other books, videos, kits, needles, buttons, and tools, plus wool samples including 160 Shetland colors by #.

Schoolhouse Press, Pittsville, WI 54466

Order (US): 800-YOU-KNIT (800-968-5648)

Questions: (715) 884-2799 Since 1959

Fax: (715) 884-2829



GGH Rebecca
Collection

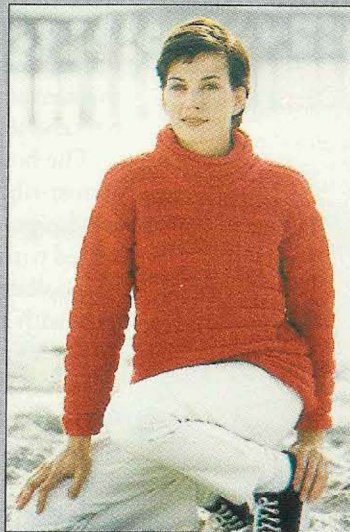

*Your knitting
inspiration
magazine!*

*Each issue
has 20
or more
wonderful
patterns.*

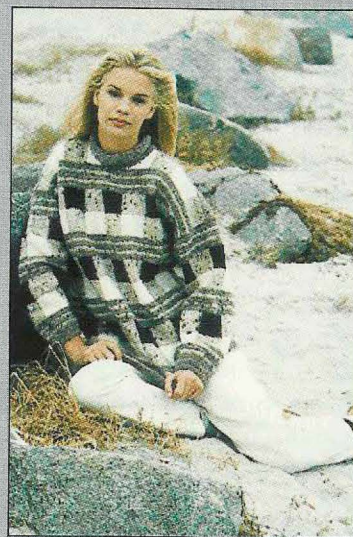

- GGH 101, Spring 1997
- GGH 102, Fall 1997
- GGH 103, Spring 1998
- GGH 104, Fall 1998

Available at fine yarn shops, or send \$11.95 USD for each ordered, and don't forget to tell us which ones you want!

Muench Yarns, Attn: Rebecca Collection

118 Ricardo Rd.

Mill Valley, CA 94941-2461

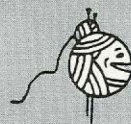

MUENCH YARNS



ST. HONORÉ

BARBARA VENISHNICK

Knitted trim

Angora collar

FINISHED SIZE 32 (34, 36, 38)" (81.5 [86.5, 91.5, 96.5] cm) bust/chest circumference, buttoned. Sweater shown measures 34" (86.5 cm).

YARN Lorna's Laces Lion & Lamb (50% silk, 50% Merino wool; 205 yd [187 m]/50 g): #11ns bold red (A), 5 (5, 6, 6) balls; Angel (70% angora, 30% lambswool; 50 yd [46 m]/50 g): jet black (D), 2 (2, 2, 2) balls. Skacel Atelier Zitron Picadilly (100% acrylic chenille; 99 yd [90 m]/50 g): #09 black (B), 7 (7, 8, 8) balls; Skacel Schoeller Esslinger Gold & Silver (80% rayon, 20% lurex; 105 yd [96 m]/50 g): #12 gold (C; used doubled), 3 (3, 4, 4) balls.

NEEDLES Body and Sleeves—Size 5 (3.75 mm): straight. Center front and lower edging—Size 5 (3.75 mm): 40" (80 cm) circular (cir). Adjust needle size if necessary to obtain the correct gauge.

NOTIONS Tapestry needle; stitch holders; size C/2 (2.75 mm) crochet hook; six $\frac{3}{4}$ " (2 cm) buttons.

GAUGE 25 sts and 32 rows = 4" (10 cm) in pattern stitch; 22 sts and 30 rows = 4" (10 cm) in St st.



Lorna's Laces Lion & Lamb singles; 12 wraps per inch

ELEGANT AND STYLISH, this fitted jacket combines the softness of a silk-wool blend with the luxury of angora and the contrasting textures of chenille and metallic lurex. Because silk alone can be too slippery to hold a shape, I chose a blend of silk and merino—the silk captures dye with shimmering color; the merino complements the silk's softness and adds stability.

The body of the jacket is worked in a cross-rib stitch that is interrupted by windowpane chenille stripes and punctuated with gold cross-stitches. The angora collar is worked in a lace stitch and ends with a ruffle and touch of gold.

Each vertical windowpane stripe is worked with a separate bobbin of chenille. The main color is carried behind the stripes in the Fair Isle style. The horizontal windowpane stripes are worked with a separate ball of chenille that is carried up the side of the knitting. Gold crosses are added after the knitting is complete.

The trims and hems are picked up and worked after the jacket pieces are knitted. This allows the braid to lie close to the knitted piece. Working in the reverse order—hem, trim, then sleeve—would create a row of purl bumps between the trim and the garment body.

Stitch

Two-Color Jewel Cross Rib: (multiple of 7 sts + 5)

Rows 1, 3, and 5: (WS) P5 with A, *k2 with B, p5 with A; rep from *.

Rows 2 and 4: K5 with A, *k2 with B, k5 with A; rep from *.

Row 6: With B, k4, *sl 1 wyb, k2, sl 1 wyb, k3; rep from *, end k1.

Row 7: With B, k4, *sl 1 wyf, k2, sl 1 wyf, k3; rep from *, end k1.

Row 8: K4 with A, *drop first slipped st off needle to front of work, sl next 2 sts to right-hand needle, drop second slipped st off needle to front of work, then pick up the first dropped st onto left-hand needle, sl 2 sts from right-

Braided Trim

This is made by placing the "floats" on the right side of the fabric.

Row 1: (WS) K1 with A, drop yarn in back of work, k1 with C (used doubled), drop yarn in back of work, k1 with B, drop yarn in back of work, *pick up A and carry it over the hanging strands of C and B and then k1 with A, drop the yarn, pick up C and carry it over the hanging strands of B and A and then k1 with C, drop the yarn, pick up B and carry it over the hanging strands of A and C and then k1 with B. Rep from *.

Note: Take care to keep the order of the colors the same; always carry the new color to be worked over the strands left hanging; maintain consistent tension that's not too tight.

Row 2: Starting with the same color that ended the previous row, say B, p1 with B, drop yarn in front of work, p1 with C, drop yarn in front of work, p1 with A, drop yarn in front of work, *pick up B and carry it over C and A and then p1 with B, drop the yarn in front of work, pick up C and carry it over A and B and then p1 with C, drop the yarn in front of work, pick up A and carry it over B and C and then k1 with A. Rep from *, matching color for color to the previous row.

Note: The yarns will get very twisted on Row 1, but then will untwist on Row 2.

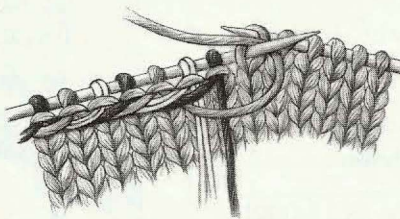

Row 1: View facing away from knitter.

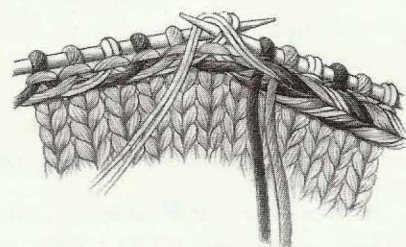

Row 2: View facing knitter.



hand needle back to left-hand needle. With the point of right-hand needle, pick up the second dropped st and place it on left-hand needle (the 2 dropped sts are crossed over 2 B sts), k1 with A, k2 with B, k4 with A; rep from *.

Rep Rows 1–8 for pattern.

•**Back:** With A, CO 103 (110, 117, 124) sts. *Set-up row:* (RS) [K5 with A, k2 with B] 14 (15, 16, 17) times, k5 with A. Cont in Two-Color Jewel Cross Rib and dec 1 st each end of needle every 4th row 12 times—79 (86, 93, 100) sts rem for waist. Cont in patt for 1" (2.5 cm). Inc 1 st each end of needle every 6th row 10 times (working new sts in patt)—99 (106, 113, 120) sts. Cont in patt until piece measures 15" (38 cm) from beg, or desired length to armholes, ending with a WS row. **Shape armholes:** BO 3 sts at beg of next 2 rows, then BO 2 sts at beg of next 2 rows. Dec 1 st each end of needle every other row 2 times—85 (92, 99, 106) sts rem. Cont in patt until armhole measures 7 (7½, 8, 8½)" (18 [19, 20.5, 21.5] cm). **Shape shoulders:** (Worked in short rows) On each of the next 2 rows, work to 8 (9, 10, 11) sts from the end and turn. On each of the next 2 rows, work to 16 (18, 20, 22) sts from the end and turn. P9 (10, 11, 12), join new yarn and BO center 35 (36, 37, 38) sts for back neck, p9 (10, 11, 12)—25 (28, 31, 34) sts rem for each shoulder. Cut yarn. Slip all sts to left needle. Working each side separately, with A and RS facing, knit 1 row. Work Braided Trim. With A, BO all sts.

•**Left Front:** With A, CO 51 (54, 58, 61) sts. *Set-up row:* (RS) K2 (5, 2, 5) with A,

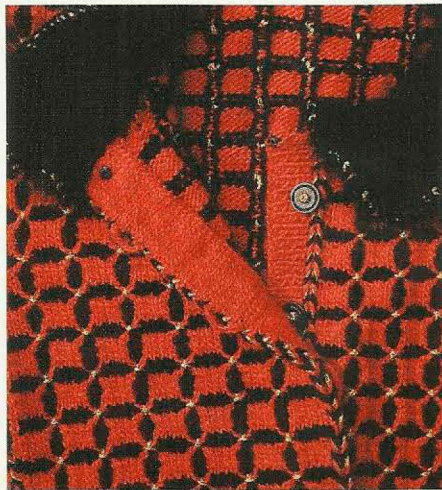

[k2 with B, k5 with A] 7 (7, 8, 8) times. Cont in Two-Color Jewel Cross Rib and work decs and then incs at beg of RS rows (side edge) as for back (working new sts in patt)—49 (52, 56, 59) sts. Cont in patt until piece measures 15" (38 cm) from beg, or desired length to armhole, ending with a WS row. **Shape armhole:** BO 3 sts at beg of next row, then BO 2 sts at beg of foll RS row. Dec 1 st at arm edge every other row 2 times—42 (45, 49, 52) sts rem. Cont in patt until armhole measures 4 (4½, 5, 5½)" (10 [11.5, 12.5, 14] cm), ending with a WS row. **Shape neck:** Cont in patt across 32 (35, 38, 41) sts and place rem 10 (10, 11, 11) sts on holder for front neck. Dec 1 st at neck edge every other row 7 times—25 (28, 31, 34) sts rem. Cont in patt until piece is same length as back to shoulder, ending with a WS row. **Shape shoulder:** BO 8 (9, 10, 11) sts at shoulder edge 2 times, then BO rem 9 (10, 11, 12) sts.

•**Right Front:** With A, CO 51 (54, 58, 61) sts. *Set-up row:* (RS) [K5 with A, k2 with B] 7 (7, 8, 8) times, k2 (5, 2, 5) with A. Cont as for left front, reversing all shaping and working front neck sts before placing them on holder (the right front will be slightly higher than the left front at the neck opening).

•**Sleeves:** With A, CO 54 (58, 61, 65) sts. *Set-up row:* (RS) K5 (7, 5, 7) with A, [k2 with B, k5 with A] 7 (7, 8, 8) times, k0 (2, 0, 2) with A. Cont in Two-Color Jewel Cross Rib, inc 1 st each end of needle every 8 rows 15 (16, 18, 19) times—84 (90, 97, 103) sts. Work even until piece measures 17 (17½, 18, 18½)" (43 [44.5, 46, 47] cm) from beg, ending with same patt row as for back before armhole shaping. **Shape cap:** BO 3 sts at beg of next 2 rows, then BO 2 sts at beg of next 2 rows. Dec 1 st each end of needle every other row 4 times—66 (72, 79, 85) sts rem. BO 2 sts at beg of every row 21 (24, 27, 30) times—24 (24, 25, 25) sts rem. BO all sts.

•**Finishing:** With C (doubled), work Embroidered Crosses on all pieces as described in box at right. With A threaded on a tapestry needle, sew fronts to back at shoulders. **Armholes and sleeves:** With A, RS facing, and beg at the first BO st on one side of the armhole and ending at the first BO st on the other side, pick up and knit 94 (100, 106, 112) sts evenly spaced around the armhole. Work Braided Trim. With A, BO all sts. Sew sleeves into armholes. With A and RS facing, pick up and knit 54 (58, 61, 65) sts along bottom edge of sleeve. Work Braided Trim. With A, purl 1 row. Work St st for 1" (2.5 cm) for

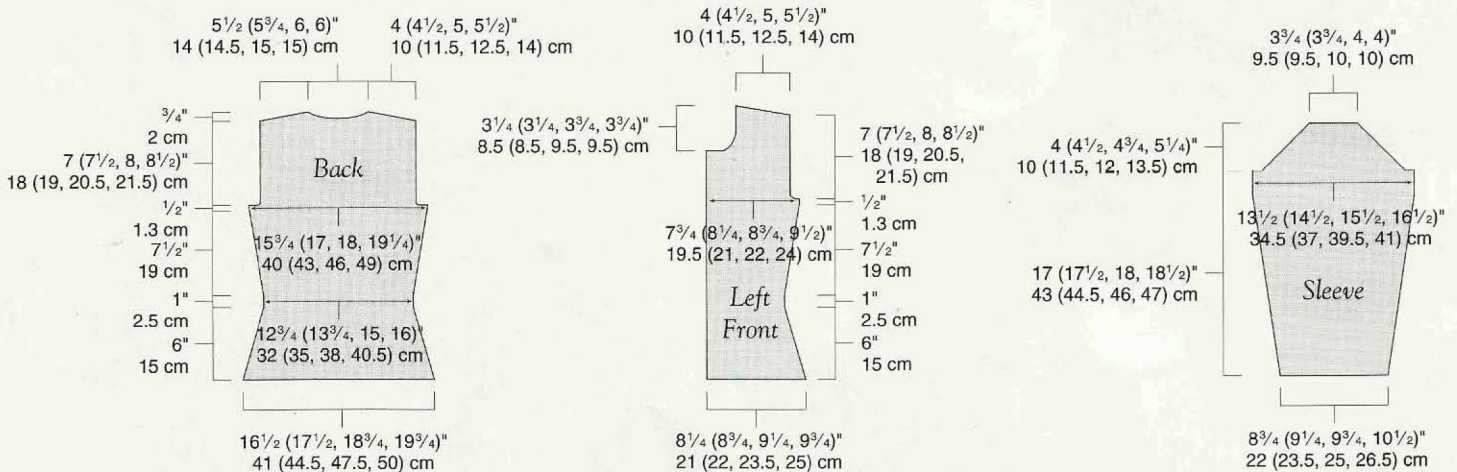

Embroidered Crosses

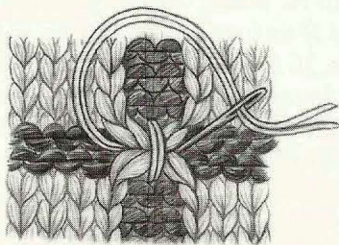

With C doubled, sew a cross on top of each knitted cross in the Two-Color Jewel Cross Rib as follows: Beg at the base of a vertical stripe of B, anchor C on the WS, *bring the needle to the RS at the top of the knitted cross and back to the WS at the base of the cross. Bring the needle again to the RS at the left side of the cross and then back to the WS at the right side. Work up the garment (weave the yarn into the WS along the channel formed by the floats) to the base of the next knitted cross. Rep from * to the top of the vertical stripe of B. Fasten off. Begin again at the base of each vertical stripe. *Note:* Take care not to pull the yarn so tightly that the garment loses its vertical stretch.

facing. BO all sts. Fold facing to inside and sew in place. **Side seams:** With A and RS facing, pick up and knit 94 sts (6 sts for every 1" of knitting) along one front side edge. Work Braided Trim. With A, BO all sts. Rep for the other front side edge. With A threaded on a tapestry needle, sew back to front along side seams close to edging. **Center front and lower edging:** With A, cir needle, RS facing, and beg at top of left front, pick up and knit 115 (118, 121, 124) sts down center front edge, 51 (54, 57, 60) sts along lower right front edge, 101 (108, 115, 122) sts along lower back edge, 51 (54, 57, 60) sts along lower right front edge, and 115 (118, 121, 124) sts up right front—433 (452, 471, 490) sts total. Do not join. Work Braided Trim. Facing: With RS facing and A only, p113 (116, 119, 122), pm, p4, pm (lower front corner), p48 (51, 54, 57), pm, p1, pm (side seam), p101 (108, 115, 122), pm, p1, pm (side seam), p48 (51, 54, 57), pm, p4, pm (lower front corner), p113 (116, 119, 122). Cont in St st, work to 2 sts from corner m, k2tog, k4, ssk, work to 2 sts from side seam m, k2tog, k1, ssk, work to 2 sts from other side seam m, k2tog, k1, ssk, work to 2 sts from other corner m, k2tog, k4, ssk, work to end of row. Cont in St st, dec 1 st on each side of lower corner markers every row and dec 1 st on each side of side seam markers every other row until facing measures 1½" (3.8 cm). BO all sts. Button placket: With RS of left front facing and beg at neck edge, use crochet hook to pull 1 loop of A through each purl bump between the facing and Braided Trim and place on a needle, ending 1½" (3.8 cm) above lower corner. Work k1, p1 ribbing for 1" (2.5 cm). BO all sts in ribbing. Fold facing to WS and sew in place. Sew buttons on placket, positioning top button 2" (5 cm) down from neck edge, lower button 1" (2.5 cm) up from lower edge, and the others evenly spaced in

PLYMOUTH YARN

The International Yarn Marketplace
Presents

GJESTAL SILJA

FINE NORWEGIAN KNITTING
IN WASHABLE WOOL BLEND



Available at your local yarn shop
or send \$7.00 plus \$1.00 postage
for Gjestal Booklet 90
including 18 patterns and names of
stockists in your area.

The Plymouth Yarn Co., Inc.
P.O. Box 28
Bristol, PA 19007

Visit our web site:
<http://www.plymouthyarn.com>

Lorna's Laces Yarns

Adding Variety to Color

Your full spectrum hand-dyed yarn source for multi-color and coordinating nearly-solid yarns in a range of fibers and weights.

Even our buttons match!



Casual Cables Cardigan

a Michele Wyman pattern
featuring Lorna's
Lion & Lamb (silk/wool blend)

ask for our yarns
at your favorite shop or mail order source
shop owner inquiries welcome
530-626-4514

P.O. Box 795, Somerset, CA 95684
miser@inforum.net

between. *Buttonholes:* With A and crochet hook, make a 5-st ch for each buttonhole. Sew buttonholes to right front opposite buttons. Weave in loose ends.

•*Collar:* With A, WS facing, and beg at left front neck edge, k10 (10, 11, 11) sts from holder, pick up and knit 18 sts along left side neck, 36 (36, 38, 38) sts along back neck, and 18 sts along right side neck, and k10 (10, 11, 11) sts from right front holder—92 (92, 96, 96) sts. Change to D.

Rows 1, 3, 5, and 7: Purl.

Rows 2 and 6: Knit.

Row 4: *K2, yo, k2tog; rep from *.

Row 8: K2, *k2, yo, k2tog; rep from *, end k2.

Work Rows 1–8 once more, then work Rows 1–3. Cut yarn. With cir needle and RS facing, pick up and knit 18 (18, 19, 19) sts along edge of left side of collar, knit across existing sts, and pick up and knit 17 (17, 18, 18) sts along edge of right side of collar—127 (127, 133, 133) sts. *Ruffle:*

Row 1: *P1, yo; rep from *, end p1.

Rows 2 and 4: Knit.

Row 3: P2, *yo, p1, yo, p3; rep from *, end last rep p2.

Row 5: Purl.

With C and D, BO as follows: K1 with D, *k1 with C, pass D st over C st, k1 with D, pass C st over D st; rep from * until no sts rem. Weave in loose ends. ∞

Barbara Venishnick lives in Simsbury, Connecticut, where she and her husband are about to become empty-nesters. She hopes to travel even more and gather inspiration for her designs.

Knit with panache! Bead with élan!

Two invaluable companions—*The Knitter's Companion* and *The Beader's Companion*—help you through every stage of your projects, from checking on the basics to achieving master touches. Each book measures 7 x 5 inches, to fit easily in your totebag or beadbox; each is spiral-bound, to lie open while you work.

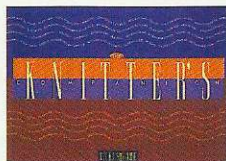

The Knitter's Companion \$17.95 plus s&h

- ◆ Casting On ◆ Joining Yarns ◆ Increases ◆ Decreases ◆ Binding Off ◆ Blocking
- ◆ Seaming ◆ Hems and Hemming ◆ Borders and Edges ◆ Buttonholes
- ◆ Yardage Estimates ◆ Body Measurement Tables ◆ Needle Conversion Charts

The Beader's Companion \$19.95 plus s&h

- Types of Beads ◆ Types of Glass and Finishes ◆ Bead Sizing ◆ Thread and Cord ◆ Waxes and Conditioners ◆ Needles ◆ Off-Loom Stitches ◆ Loom Techniques ◆ Stringing Beads ◆ Embroidery Techniques ◆ Knitting and Crochet with Beads ◆ Finishings ◆ Macramé ◆ Findings ◆ Wirework ◆ Beader's Graph Paper ◆

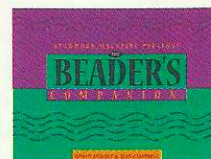

To order your faithful knitting and beading companions, call 800-289-9276.

INTERWEAVE BOOKS 1338 Ross Street Petaluma, CA 94954 <http://www.interweave.com>



A STITCH ABOVE™

FINE YARNS * NEEDLEWORK * BUTTONS

Specializing in natural fiber yarns in all price ranges, including a large selection of washable wools and cottons.

- ROWAN
- JO SHARP
- ALICE STARMORE
- MISSONI - BERROCCO
- DALE OF NORWAY
- CYNTHIA HELENE
- ANNABEL FOX - MANDS
- ADRIENNE VITTADINI
- BROWN SHEEP - LOPI - STAHL
- CLASSIC ELITE - TAHKI - LANG

WWW.ASTITCHABOVEKNITTING.COM

1-800-949-KNIT (5648)

190 WAYLAND AVE. PROVIDENCE, RI 02906

FRENCH YARNS

FOR HANDKNITTING, MACHINE-KNITTING, & NEEDLEPOINT

JASMINE® SILK, PARISIAN COTTON®,

BELANGOR® ANGORA,

KILHIM® EGYPTIAN COTTON,

MERINO KING®, ECOWOOL®,

FLORE® KID MOHAIR,

KISMET® METALLIC,

CASHMERE & WOOL,

CASHMERE & SILK BLENDS.

SUPPLYING RETAIL STORES, DESIGNERS,

MANUFACTURERS & KIT MAKERS

FOR INFORMATION &/OR ALBUM PLEASE CALL

1-800-836-3314

Galler Yarns

JOSEPH GALLER YARNS, INC.

MONROE, NEW YORK 10950-9736



GIVE YOUR SWEATERS THE TLC THEY REALLY NEED WITH

Eucalan No-Rinse Woolwash

Woolwash cleans and conditions in one easy step . . . there's no rinsing! The natural lanolin conditions the fibers while the fresh smelling eucalyptus helps protect against moths. Woolwash is ideal for use by hand or machine.

(Always store your sweaters clean.)

- Safe for all fine washables
- Contains no harsh chemicals
- Not tested on animals
- Earth friendly

Available from fine yarn stores everywhere

For a free sample (one per household please), send a copy of this ad and a postage stamp to:

USA: Eucalan Sample
Department B
9861 Holland-Glenwood Rd.
Glenwood, NY 14069

CANADA: Eucalan Sample
Department B
PO Box 374
Paris, ON, Canada N3L 3T5

EUCALAN, INC.

1-800-561-9731 Dealer Inquiries Welcome



Experience the WILDS of Montana

Hand-painted yarns in 25 inspiring colorways

(406) 777-3377 for a dealer nearest you





PURPLE PASSION PULLOVER

NICKY EPSTEIN

*Appliqué and bead
embellishment*

Luscious kid mohair

FINISHED SIZE 41 (46, 51)" (104 [117, 129.5] cm) bust/chest circumference. Sweater shown measures 41" (104 cm).

YARN Muench GGH Soft Kid (70% super kid mohair, 25% polyamid, 5% wool; 138 m [150 yd]/50 g): #53 purple (MC), 15 (17, 19) balls; #13 orchid, 3 balls; #31 grape, #33 navy, 1 ball each.

NEEDLES Size 7 (4.5 mm): straight, 16" (40 cm) circular (cir), and double-pointed (dnp). Adjust needle size if necessary to obtain the correct gauge.

NOTIONS Stitch holder; tapestry needle; 170 matching bugle beads.

GAUGE 20 sts and 24 rows = 4" (10 cm) in St st.



Muench GGH Soft Kid; interlocking fibers; 14 wraps per inch

THIS MOHAIR-BLEND boxy pullover features vented sides, a boat neck, and free-form embellishments.

The body is worked in reverse stockinette stitch and the edgings are worked in k1, p1 ribbing, followed by a combination of the ribbing and reverse stockinette stitch. The boat neck is subtly shaped in the back with decreases worked in the ribbing. Except for the stem stitch used to "connect" the bobbles to the I-cord stems, all embellishments are made separately and then sewn onto the sweater body. Bugle beads add sparkle to the leaves and elegance to the sweater. The yarn is lightweight and soft, and the mohair texture adds interest to the design. **Note:** Work yarn double throughout.

Stitches

Reverse Stockinette Stitch: (rev St st)

Row 1: (RS) Purl.

Row 2: Knit.

Rep Rows 1 and 2 for pattern.

I-cord: With dnp, CO 3 sts. *K3, slide sts to other end of needle; rep from * for recommended length. BO all sts. **Note:** Inc 2 sts in last row (5 sts total) and do not BO if a leaf is to be worked on the cord.

Small Leaf: (worked on 5 sts at end of I-cord)

Row 1 (RS): K2, yo, k1, yo, k2—7 sts.

Row 2 and foll WS rows through Row 12: Purl.

Row 3: K3, yo, k1, yo, k3—9 sts.

Row 5: K4, yo, k1, yo, k4—11 sts.

Row 7: SSK, k7, k2tog—9 sts.

Row 9: SSK, k5, k2tog—7 sts.

Row 11: SSK, k3, k2tog—5 sts.

Row 13: SSK, k1, k2tog—3 sts.

Row 14: Sl 1, p2tog, pss0—1 st.

Fasten off.

Large Leaf: (worked on 5 sts at end of I-cord)

Rows 1–6: Rep Rows 1–6 for Small Leaf.

Row 7: K5, yo, k1, yo, k5—13 sts.

Row 8 and all foll WS rows through Row 16:

Purl.

Row 9: SSK, k9, k2tog—11 sts.

Row 11: SSK, k7, k2tog—9 sts.

Row 13: SSK, k5, k2tog—7 sts.

Row 15: SSK, k3, k2tog—5 sts.

Row 17: SSK, k1, k2tog—3 sts.

Row 18: Sl 1, p2tog, pss0—1 st.

Fasten off.

Bobble: (Knit into front and back of same st) 2 times, then knit into front again—5

sts, turn. Work these 5 sts in St st for 4 rows. K2tog, k1, k2tog, turn. P3tog—1 st rem. Fasten off.

•**Back:** With MC (doubled), CO 101 (113, 125) sts. Work k1, p1 ribbing until piece measures 2¼" (5.5 cm), ending with a RS row. **Set-up row:** (WS) P1, [k1, p1] 2 times, k7, *[p1, k1] 2 times, p1, k7; rep from * 7 (8, 9) times total, end [p1, k1] 2 times, p1. Work rib and rev St st as established until piece measures 3½" (9 cm) from beg, inc 1 st at each end of needle on last row—103 (115, 127) sts. Cont in rev St st only and work even until piece measures 21 (23, 25)" (53.5 [58.5, 63.5] cm) from beg, ending with a WS row. Place sts on holders as follows: 25 (29, 33) sts for each shoulder, 53 (57, 61) sts for back neck.

•**Front:** Work as for back until piece measures 19½ (20½, 22)" (49.5 [52, 56] cm) from beg, ending with a RS row. **Shape neck:** (WS) K37 (43, 49), *[p1, k1] 2 times, p1, k7; rep from * once more, [p1, k1] 2 times, p1, k37 (43, 49). Cont as established for 3 more rows. **Next row:** K25 (31, 37), *[p1, k1] 2 times, p1, k7; rep from * 3 more times, [p1, k1] 2 times, p1, k25 (31, 37). Cont as established until piece measures same as back. Place sts on holders as for back.

•**Sleeves:** With MC (doubled), CO 41 (45, 49) sts. Work k1, p1 ribbing until piece measures 2¼" (5.5 cm), ending with a RS row. **Set-up row:** (WS) K0 (2, 4), *p1,





[k1, p1] 2 times, k7; rep from *, 3 times total, end [p1, k1] 2 times, p1, k0 (2, 4). Work rib and rev St st as established until piece measures 3½" (9 cm) from beg. Cont in rev St st only and inc 1 st each end of needle every 2 rows 10 (9, 6) times, then every 4 rows 16 (17, 20) times—93 (97, 101) sts. Work even until sleeve measures 18½ (19, 20)" (47 [48.5, 51] cm) from beg, or desired length to underarm, ending with a WS row. BO all sts.

•**Finishing: Shoulders:** Place shoulder sts on needles. With RS facing, BO shoulder sts tog (see Glossary, page 6). **Neckband:** (RS) Beg at left shoulder, sl 53 (57, 61) front neck sts and 53 (57, 61) back neck sts onto cir needle. Place m and join. With MC (doubled), work k1, p1 rib across 53 (57, 61) front sts, cont in rib for 6 (5, 4) sts, work 2 sts tog, * rib 6 (3, 2) sts, work 2 sts tog; rep *, end rib 5 (5, 3) sts—100 (104, 108) sts rem. Cont in established rib until neckband measures 2" (5 cm). BO all sts. **Bobbles:** With grape (doubled), make 46 bobbles; with navy (doubled), make 24 bobbles; leaving tails at least 1½" (3.8 cm) long on each for attaching to sweater. **Cords:** With orchid (doubled), make I-cord as follows: two cords 1" (2.5 cm) long, four cords each 2" (5 cm), 4" (10 cm), and 6" (15 cm) long. **Cords with small leaves:** With orchid (doubled), make the following lengths of I-cord, ending each with a small leaf: eight 1½" long (3.8 cm), ten 2½" (6.5 cm) long, and four 6" (15 cm) long. **Cords with large leaves:** With orchid (doubled), make the following lengths of I-cord, ending each with a large leaf: four 6" (15 cm) long, two 9½" (24 cm) long, two 14" (35.5 cm) long, and two 17" (43 cm) long. With a single strand of yarn threaded on a tapestry needle, sew cords, leaves, and bobbles to sweater foll diagrams. With grape (doubled), work stem st "connecting" bobbles to stems. Sew 5 beads to each leaf as shown. With a single strand of yarn threaded on a tapestry needle, sew sleeves into armholes and sew sleeve and seams. Sew side seams from top of ribbing to underarm—3½" (9 cm) vent at lower edge. Weave in loose ends.

Nicky Epstein, author of *The Knit Hat Book* (Taunton Press, 1997), lives in New York City where she is working on a new book on knitted borders, edgings, and embellishments. Look for her book *Decorative Knitting from Interweave Press* in early 1999.

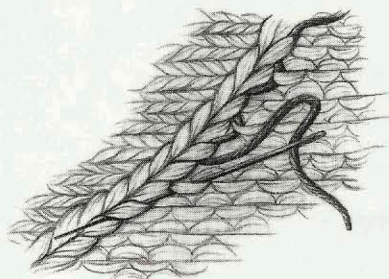

Sew leaves to sweater with single strand of yarn.

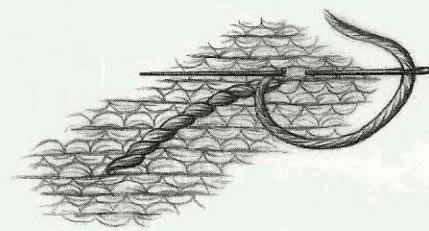

Stem stitch.

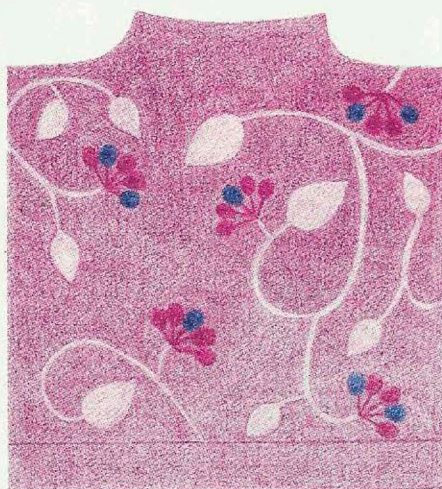

Attach cords, leaves, and bobbles to the front, back, and sleeves as shown. Work stem stitch between bobbles and cords.



Sew five bugle beads to each leaf.

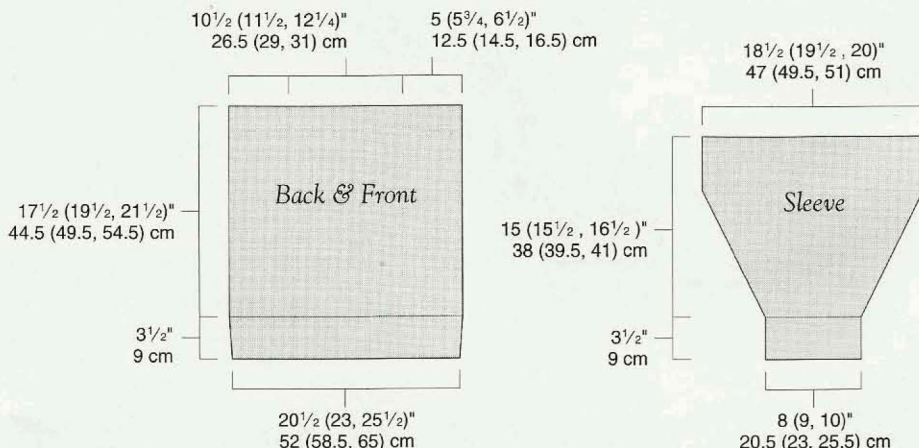

New Cashmere ♦ Silk Yarns





\$18.00/year - Six Issues... Includes
Five Exciting yarns to Swatch • Newsletters
Exclusive Patterns • Huge Savings



The Swatch Club™
Call 1-800-558-5262 to order
VISA/MC accepted!

♦ For Discerning Knitters ♦

PANGAIA

Kit
Set - \$173.00
Cardigan Only - \$105.50
Pullover Only - \$109.50
(+\$6.50 S&H)
Pattern
\$15.95 (+\$2.50 S&H)

Susuavor Adanudo
African inspired cropped cardigan & pullover set
from designer Sarah Madrid. Kits include Tahki
Cotton Classic & pattern with the sweater graphed
on easy-to-read symbolized graphs.

More African
designs available!
Send \$3 for catalog
Wholesale inquiries
Welcome

Produced & distributed exclusively by:

♥ **Sealed With A Kiss, Inc.** ♥
2022 W. Noble Guthrie, OK 73044
(405) 282-8649

JACQUELINE'S SECRET

CAMISOLE IN FRENCH SILK
DESIGNED BY JACQUELINE OLSEN

The newest knitter's kit by Jacqueline Olsen, available only from Amazing Threads. Elegantly simple mitering creates a superb shape. The knitted camisole is endlessly versatile . . . to wear as lingerie, soften the look of a tailored jacket for work, pair with a cardigan, wear alone as a warm weather top, or team with a formal skirt for evening. Accented with lovely, easy-to-knit diamond eyelet edging and straps. Knit in lustrous, pure silk yarn from France in jet black, blush, red or royal blue. Kit includes yarn and pattern for sizes 30, 34, 38 and 42.

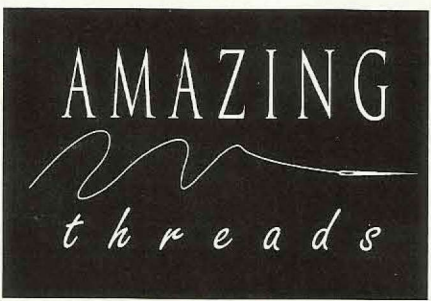

Kit, \$119
(Add \$6 S/H for US destinations)
NY residents add sales tax.
Pattern not sold separately.

ORDER TOLL-FREE
1-888-SEW-KNIT

Questions?
1-914-336-5322

AMAZING THREADS, LTD.
2010 ULSTER AVENUE, POST OFFICE BOX 758
LAKE KATRINE, NY 12449

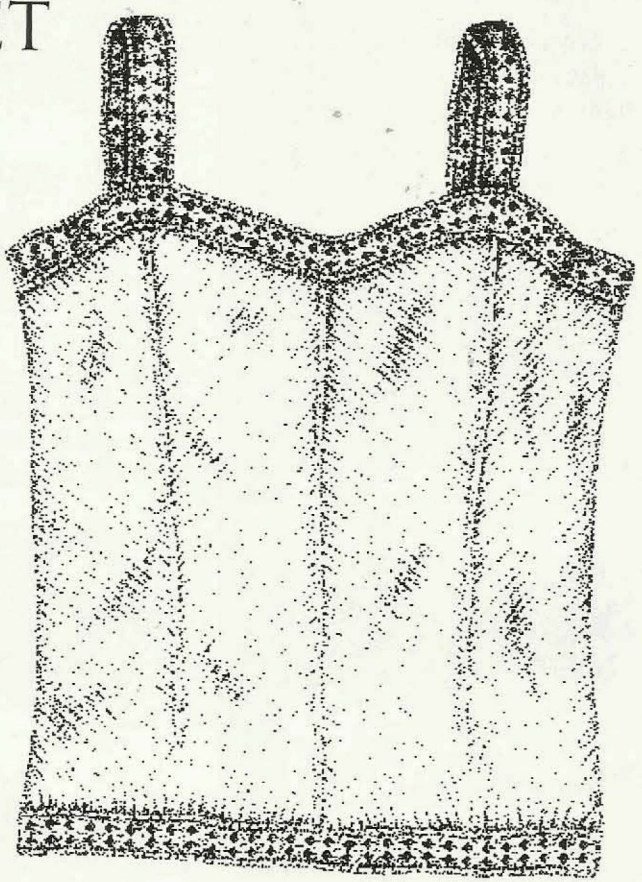



A NATURAL FLAIR

BIRGITTA STOLPE

Form-fitting

Edged with lace

FINISHED SIZE 35 (37, 39)" (89 [94, 99] cm) bust/chest circumference. Sweater shown measures 37" (94 cm).

YARN Berroco SensuWool (80% wool, 20% nylon; 96 yd [88 m]/50 gm): #6534 Beaujolais, 13 (14, 15) skeins.

NEEDLES Size 6 (4 mm). Adjust needle size if necessary to obtain the correct gauge.

NOTIONS Markers (m); tapestry needle; size F/5 (3.75 mm) crochet hook.

GAUGE 19 sts and 28 rows = 4" (10 cm) in St st.



Berroco SensuWool
2-ply; 14 wraps per inch

THIS FORM-FITTING TUNIC has sixties-inspired belled sleeves and a scalloped lace border. The tapered lines are made with strategically spaced decreases and increases. The lower back edge is wider and tapers more quickly to the waist than the front, providing a flattering fish-tail back. The bodice is fitted with knitted-in darts. The neck is finished with a simple single crochet edge. The fluidity of Berroco's SensuWool is ideal for this drapey style.

Note: The length and placement of the darts are key to a good fit. If you're particularly long- or short-waisted, take time to measure yourself and adjust the pattern between the dart sequences to fit your contours—the bust darts should end about one inch below your bust line and the waist darts should begin slightly below and end slightly above your natural waistline.

Abbreviations

MIL: With left needle tip, lift the strand between the last knitted st and the first st on the needle, from front to back. Knit the lifted loop through the back.

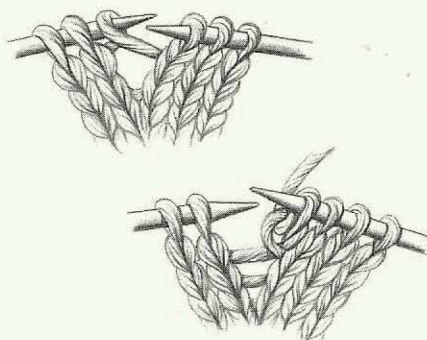

MIR: With left needle tip, lift the strand between the last knitted st and the first st on the needle, from back to front. Knit the lifted loop through the front.

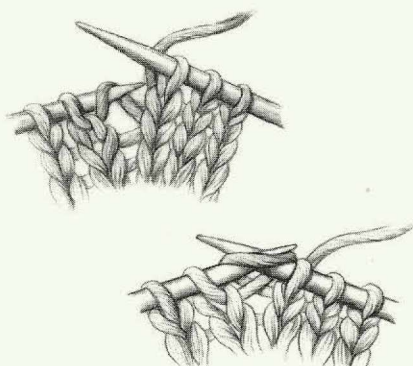

Stitches

Scalloped Edging: (multiple of 18 sts + 2)
Row 1: K1 *[k2tog] 3 times, [yo, k1] 6 times, [ssk] 3 times; rep from *, end k1.

Row 2: Purl.

Rep Rows 1 and 2 for pattern.

Darts: Worked on either side of a pivotal st (PS).

Alternating Single Decrease (ASD): (worked over 5 sts) One st is dec'd on the right side of PS on the first dec row and on the left side of PS on the next dec row.

ASD #1: Work to 2 sts before PS, ssk, k1 (PS).

ASD #2: Work to PS, k1 (PS), k2tog.

Alternate working ASD #1 on one dec row and ASD #2 on the next dec row.

Double Decrease Dart (DDD): (worked over 5 sts) Work to 2 sts before PS, ssk, k1 (PS), k2tog.

Alternating Single Increase (ASI): (worked over 5 sts) One st is inc'd on the right side of PS on the first inc row and on the left side of PS on the next inc row.

ASI #1: Work to PS, MIR, k1 (PS).

ASI #2: Work to PS, k1 (PS), MIL.

Alternate working ASI #1 on one inc row and ASD #2 on the next inc row.

•**Back:** CO 146 sts. Knit 3 rows. Work Scalloped Edging for 8 rows. *Set-up row:* K1, k2tog, [k14, ssk, k2tog] 7 times, k14, ssk, k1—130 sts rem. Change to St st and mark 41st and 89th sts as pivotal sts (PS). *Dec row:* K2tog, k36, DDD, k45, DDD, knit to last 2 sts, ssk—6 sts dec'd. Dec in this manner every 6 (6, 8) rows 11 (10, 9) times more, being careful to place each DDD over PS—58 (64, 70) sts rem. Work even until piece measures 13½ (14, 14½)" (34.5 [35.5, 37] cm) from beg. *Inc row:* Inc in first st, work to last st while working ASI #1 centered over each PS, inc in last st—4 sts inc'd. Inc in this manner (alternating ASI #2 and ASI #1) every 8 rows 5 more times—82 (88, 94) sts. Work even until piece measures 19 (20½, 22)" (48.5 [52, 56] cm) from beg, ending with a WS row. **Shape armholes:** At each arm edge, BO 5 sts, then 2 sts, then 1 st 2 times—64 (70, 76) sts rem. Work even until armhole measures 6 (6½, 7)" (15 [16.5, 18] cm), ending with a WS row. **Shape shoulders:** K17 (19, 21), join new yarn and BO 30 (32, 34) sts for neck, and knit to end. Working each side separately, dec 1 st at neck edge every row 4 times—13 (15, 17) sts rem each side. Purl 1 row. BO all sts.



•**Front:** CO 128 sts. Knit 3 rows. Work Scalloped Edging for 8 rows. *Setup row:* K1, k2tog, [k14, ssk, k2tog] 6 times, k14, ssk, k1—114 sts rem. Change to St st. Mark the 33rd and 81st sts as PS and work single decs (ASD) around these sts. Work dec rows as for back, alternating ASD #1 and ASD #2 (instead of working DDD) every 6 (6, 8) rows 11 (10, 9) times total—70 (74, 78) sts rem. Work even until piece measures 13½ (14, 14½)" (34.5 [35.5, 37] cm) from beg. Inc as for back every 10 (12, 10) rows 3 (3, 4) times total—82 (86, 94) sts. Work even until piece measures same as back to armholes. **Shape armholes:** At each arm edge, BO 5 sts, then 2 sts, then 1 st 2 (1, 2) time(s)—64 (70, 76) sts rem. Work even until armhole measures 2½ (2½, 3)" (6.5 [6.5, 7.5] cm), ending with a WS row. **Shape neck:** K23 (25, 27), join new yarn and BO 18 (20, 22) sts for neck, and knit to end. Working each side separately, BO at neck edge as follows: 2 sts 2 times, 1 st 2 times, then BO 1 st every 4th row 4 times—13 (15, 17) sts rem. Cont even until armhole measures 7 (7½, 8)" (18 [19, 20.5] cm). BO all sts.

•**Sleeves:** CO 92 sts. Knit 3 rows. Work Scalloped Edging for 8 rows. *Setup row:* K1, k2tog, [k14, ssk, k2tog] 4 times, k14, ssk, k1—82 sts rem. Change to St st. Mark the 27th and 55th sts as PS and work ASD around these sts. Work dec rows as for back every 6 (6, 8) rows 8 (7, 6) times—50 (54, 58) sts; piece should measure 6¼ (6, 6½)" (16 [15, 16.5] cm) from beg of St st. Work even for 1" (2.5 cm). Then inc 1 st each end of needle every 12 (13, 13) rows 5 times—60 (64, 68) sts; piece should measure 17½ (18, 18½)" (44.5 [46, 47] cm) from beg (including Scalloped Edging). **Shape cap:** At each side, BO 5 sts once, 2 sts once, 1 st 11 (13, 15) times, 2 sts 2 times, and then 5 sts once. BO rem 6 sts.

•**Finishing:** With yarn threaded on a tapestry needle, sew shoulder, side, and sleeve seams. Sew sleeves into armhole openings. Weave in loose ends. With crochet hook, work 1 row of single crochet (see Glossary, page 7) around neck edge. Block or steam. ∞

Birgitta Stolpe of Chicago, Illinois, always has several projects going. She loves traditional sportswear sweaters, especially the heavily cabled ones which her friends insist she can do in her sleep. But when she wants to challenge herself as a designer and knitter, she plays around with silhouettes and interpreting non-knitted garments into knitted pieces. She's fascinated by the many ways darts can add interest and complexity to otherwise simple garments.

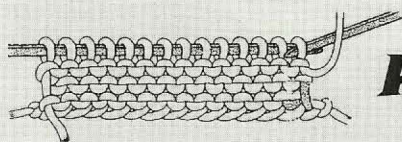
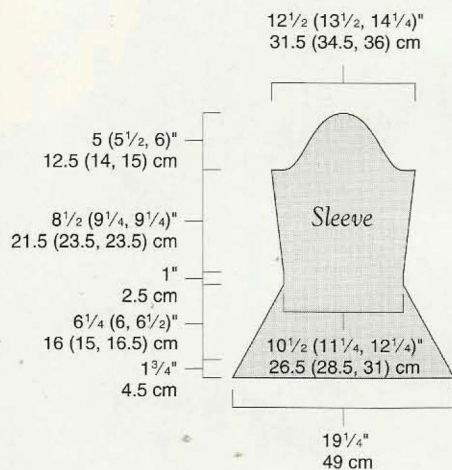
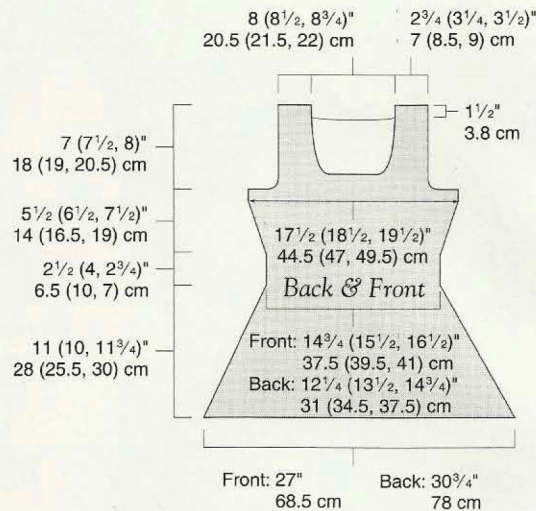

Smooth & Comfortable

Crystal Palace Yarns has 3 types of needles for your knitting pleasure:

— SWALLOW CASEIN —
made of milk protein

— CPY BAMBOO —
the top quality bamboo needle

— HOBI —
aluminum with a silky finish

Animal * Vegetable * Mineral

Knitters:

Ask for needles from
Crystal Palace Yarns
at your favorite shop.

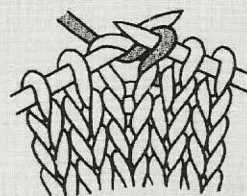

Wholesale Distributors:

For all three types: **Crystal Palace Yarns**, 3006 San Pablo Ave., Berkeley, CA 94702. (510) 548-9988 <http://www.straw.com/cpy>

For just Casein: **Design Source**, 38 Montvale Ave., Suite 350, Stoneham, MA 02180. (888) 566-9970

BESTSELLERS FROM INTERWEAVE PRESS



New!

The Lacy Knitting of Mary Schiffmann

Nancy Nebring

- ◆ Patterns from a lifetime of collecting
 - ◆ Projects that range from lace and edgings to a christening gown
- 8½ × 9, paperbound, 96 pages, charts and duotone photos. #776—\$17.95 + s&h

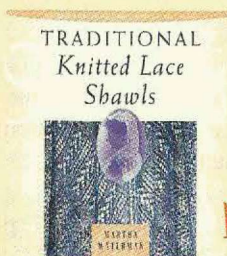

New!

Traditional Knitted Lace Shawls, Revised Edition

Martha Waterman

- ◆ Detailed corrected instructions for eight shawls—triangles, squares, circles, half-circles
 - ◆ All-new photography
- 8½ × 9, paperbound, 112 pages, charts and duotone photos. #911—\$21.95 + s&h

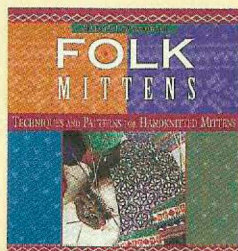

Folk Mittens

Marcia Lewandowski

- ◆ 38 patterns from around the world, each with a full-color graph
 - ◆ Technical coverage for gauge, washing and felting, casting on, cuffs, thumbs
- 8½ × 9, paperbound, 120 pages, 38 charts and patterns. #694—\$18.95 + s&h

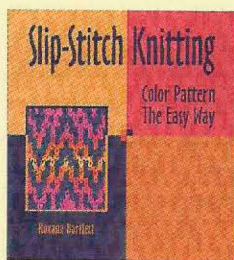

Slip-Stitch Knitting Color Pattern the Easy Way

Roxana Bartlett

- ◆ Intricate multicolored patterns without having to carry two yarns
 - ◆ Instructions for 13 original garments
- 8½ × 9, paperbound, 96 pages, 36 color photos. #683—\$21.95 + s&h

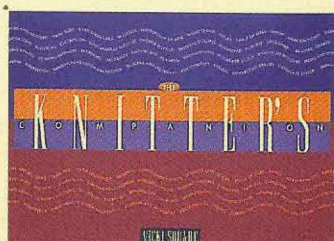

The Knitter's Companion

Vicki Square

- ◆ Illustrated diagrams for a wide range of knitting techniques, plus button-holes, seams and hems, body measurements, and yarn estimates
 - ◆ Fits in your tote bag, stays open while you knit
- 7 × 5, spiral-bound, 112 pages, b&w technique illustrations. #671—\$17.95 + s&h

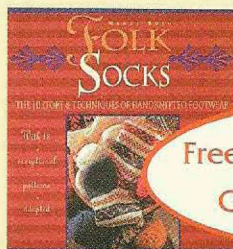

Folk Socks

Nancy Bush

- ◆ 18 great sock patterns from a host of folk knitting traditions
 - ◆ Technical coverage for heel turnings, toe shapings, and top ribbings
- 8½ × 9, paperbound, 120 pages, color and b&w photos. #654—\$16.95 + s&h

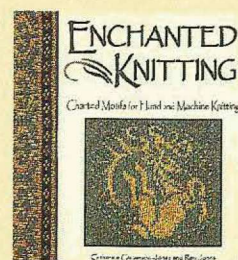

Enchanted Knitting Charted Motifs for Hand and Machine Knitting

Catherine Cartwright-Jones and Roy Jones

- ◆ Ancient, natural, mythological, and imperial motifs
 - ◆ Charted designs and photos
- 8½ × 10, paperbound, 96 pages, color photos and b&w charts. #680—\$19.95 + s&h

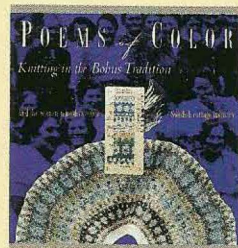

Poems of Color Knitting in the Bohus Tradition

Wendy Keele

- ◆ History of Sweden's Bohus workshop
 - ◆ Instructions for 17 garments/46 designs
- 8½ × 9, paperbound, 144 pages, color and b&w historical photos. #662—\$19.95 + s&h

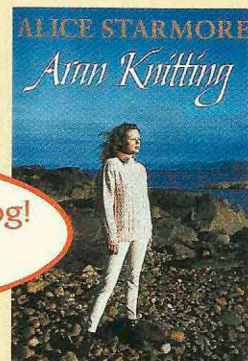

Aran Knitting

Alice Starmore

- ◆ Complete Alice Starmore workshop
 - ◆ 60 charted patterns/14 garments
- 8½ × 12, hardbound, 176 pages, color photos. #723—\$39.95 + s&h

Free Interweave Catalog!
Call 800-289-9276!

To charge these books, call Dept. IWPK at 800-289-9276 or use the order form on page 4.
Interweave Books 1338 Ross Street Petaluma, CA 94954-6502 <http://www.interweave.com>



STRANDS OF PEARLS PULLOVER

DIANE ZANGL

Worked in the round

Bead embellishment

FINISHED SIZE 34½ (38½, 42¼, 46)" (87.5 [98, 107.5, 117] cm) bust/chest circumference. Sweater shown measures 38½" (98 cm).

YARN Rowan True 4-ply Botany (100% wool; 155 yd [140 m]/50 g): #545 Snowdrop, 8 (8, 9, 11) balls.

NEEDLES Body and Sleeves—Size 5 (3.75 mm): 16" and 24" (40 and 60 cm) circular (cir); Edgings—Size 3 (3.25 mm): 16" and 24" (40 and 60 cm) cir and double-pointed (dpn). Adjust needle sizes if necessary to obtain the correct gauge.

NOTIONS Cable needle (cn); markers (m); stitch holders; size 0 (3.25 mm) steel crochet hook; four ¾" (1 cm) JHB International buttons: #11260 Frosty Full Balls; about 550 4-mm round pearl beads; about 550 oval (3 mm × 6 mm) pearl beads.

GAUGE 25 sts and 30 rnds = 4" (10 cm) in circular St st on larger needle.



Rowan True 4-ply Botany; 4-ply; 14 wraps per inch

THIS CLASSICALLY-STYLED yoke pullover is worked in the round and features large and small cables alternating with areas of plain stockinette stitch. Decreases are worked in the plain areas to shape the yoke. Three cables start at the cuff and travel up the sleeve where the cables flow into the yoke design. A small stand-up collar is worked in baby cable rib, as are the lower body and sleeve edgings. The collar is closed on the left side by a row of small pearl buttons—the fine yarn make these dressmaker's details possible. This very soft, sport-weight wool also gives the sweater supple drape and a light feel. Adding a look of understated elegance are 4-mm pearl beads that grace the diminutive cables of the yoke and collar.

The width of the stockinette-stitch areas between each cable determines the yoke circumference. All decreases are made in these sections (see Sleeve and Yoke chart). The collar size is determined by the number of purl stitches between cables (see Collar chart). The sweater body and sleeves are worked separately in the round to the underarms. The cables in the baby ribbing move up into the sleeve cables; increases are hidden in the cables. The pieces are joined and the yoke is worked in the round to the neck opening, then the collar is worked back and forth in rows. Beads are sewn on after the garment is completed.

Abbreviations

2/2LC: Sl 2 sts onto cn and hold in front, k2, k2 from cn.

3/3LC: Sl 3 sts onto cn and hold in front, k3, k3 from cn.

dbl dec: Sl 2tog kwise, k1, p2_{ss}o.

Stitch

Baby Cable Rib: (multiple of 4 sts + 2) Rnds 1, 3, and 4: P1, *k2, p2; rep from *, end last rep p1.

Rnd 2: P1, *k2tog but leave st on needle, then knit the first st again, p2; rep from *, end last rep p1.

Rep Rnds 1–4 for pattern.

•**Body:** With longer edging needle, CO 200 (216, 232, 248) sts. Place m and join, being careful not to twist sts. Work Baby Cable Rib until piece measures 2" (5 cm) from beg, ending with Rnd 2 of patt. *Inc rnd:* M1 by picking up and knitting into the horizontal bar bet 2 knit sts of cable cross 16 (24, 32, 40) times as follows: For

small size only: K6, *M1, k12; rep from * 16 times, end k2. *For medium size only:* K6, *M1, k8; rep from * 12 times, k12, rep from * 12 times, k6. *For large size only:* *K6, [M1, k8, M1, k4] 4 times, k8, [k4, M1, k8, M1] 4 times, k6; rep from * once more. *For extra-large size only:* *K2, [M1, k8, M1, k4] 5 times, [k4, M1, k8, M1] 5 times, k2; rep from * once more—216 (240, 264, 288) sts. Change to longer body needle and work St st until piece measures 13 (13, 13½, 14)" (33 [33, 34.5, 35.5] cm) from beg, ending 6 (8, 10, 12) sts before m. **Shape armholes:** K12 (16, 20, 24) and place on holder for left underarm, k108 (120, 132, 144) sts and place last 12 (16, 20, 24) sts knitted on another holder for right underarm, knit to end of rnd—96 (104, 112, 120) sts rem each for front and back. Do not cut yarn. Set aside.

•**Sleeves:** With smaller dpn, CO 48 sts. Place m and join, being careful not to twist sts. Beg with k2, work Baby Cable Rib until piece measures 2½" (6.5 cm) from beg. *Inc Rnd:* For *small size only:* K3, [M1, k4] 2 times, M1, p1, k1, M1, k2, p1, k2tog, k2, k2tog, p1, k1, M1, k2, M1, k1, p1, k2tog, k2, k2tog, p1, k2, M1, k1, p1, M1, [k4, M1] 2 times, k1. *For medium size only:* K3, [M1, k4] 2 times, M1, p1, k2, M1, k1, p1, k2, k2tog, k2, p1, k1, M1, k2, M1, k1, p1, k2, k2tog, k2, p1, k2, M1, k1, p1, M1, [k4, M1] 2 times, k1. *For large size only:* K3, [M1, k4] 2 times, M1, p1, k1, M1, k2, p1, k6, p1, k1, M1, k2, M1, k1, p1, k6, p1, k2, M1, k1, p1, M1, [k4, M1] 2 times, k1. *For extra-large size only:* K3, [M1, k4] 2 times, M1, p1, k1, M1, k2, p1, k3, M1, k3, p1, k1, M1, k2, M1, k1, p1, k3, M1, k3, p1, k2, M1, k1, p1, M1, [k4, M1] 2 times, k1—54 (56, 58, 60) sts. Change to larger dpn. Remove m, k1, pm (to establish new beg of rnd), k13, pm, work 28 (30, 32, 34) sts according to Row 1 of Sleeve and Yoke chart (from A to C), pm, k12. Cont in established patt, inc 1 st each side of beg-of-rnd m every 4 rnds 8 (12, 16, 20) times and changing to cir needle when necessary—70 (80, 90, 100) sts. Cont even until piece measures about 17 (17½, 18, 18½)" (43 [44.5, 46, 47] cm) from beg, ending with Row 6 of chart. *Next rnd:* Cont in patt to 6 (8, 10, 12) sts from m, place next 12 (16, 20, 24) sts on holder. Cut yarn, leaving an 18" (46 cm) tail for seaming later. Join left sleeve to body as follows: With needle holding body sts, work rem 58 (64, 70, 76) left sleeve sts in



patt, pm, work 96 (104, 112, 120) front sts. Set aside. Make right sleeve.

•**Yoke:** Pick up needle with held body and left sleeve sts, pm, work across right sleeve sts, pm, work 96 (104, 112, 120) back sts, pm (beg of rnd)—308 (336, 364, 392) sts total. Set up cable patt as follows: K3 (4, 6, 6), p1, 3/3LC, p1, k4 (5, 6, 7), beg with Row 8, work Sleeve and Yoke chart (from A to B) across 286 (312, 338, 364) sts, p1, 2/2LC, p1, k1 (1, 0, 1)—14 patt reps total; small cable centered at sweater front. Cont in established patt until yoke measures 4 (4, 4½, 4¾)" (10 [10, 11.5, 12] cm) from beg. *Dec rnd:* Dec in each St st section as follows: SSK, k2 (1, 2, 3), [k2tog] 0 (1, 1, 1) time—280 (280, 308, 336) sts rem. Cont in patt until yoke measures 6 (6, 6, 6½)" (15 [15, 15, 16.5] cm). *Dec rnd:* Dec in each St st section as follows: [SSK] 0 (0, 1, 1) time, k1 (0, 0, 1), [k2tog] 1 (0, 1, 1) time, work dbl dec 0 (1, 0, 0) time—252 (224, 252, 280) sts rem. Cont in patt until yoke measures 8 (8, 8½, 8)" (20.5 [20.5,

21.5, 20.5] cm). *Dec rnd:* Dec in each St st section as follows: [P2tog] 2 (1, 2, 0) time(s), work dbl dec 0 (0, 0, 1) time(s), p0 (1, 0, 0)—196 (196, 196, 224) sts rem. *For large size only:* Cont in patt until yoke measures 9" (23 cm), then dec in each St st section as follows: P2tog, p1—196 sts rem. *For all sizes:* Cont in established patt through Rnd 1 or 5 (whichever comes first) of chart. Cut yarn. Mark center front 32 (32, 36, 36) sts, using front markers as a guide. Slip half of left sleeve sts (to the middle of center 6-st cable) to right-hand needle. **Shape left neck and opening:** With RS facing, join yarn. Work in patt to marked front sts (do not work marked sts), turn, sl 1, work to end of row (center of left sleeve). [Work to 1 cable section from last turning, p1, wrap st (see box below), turn, work to end] 4 times. *Note:* After each turn, there will be 1 less cable section to work. Cut yarn. Place sts just worked on holder. **Shape right neck:** Sl marked center front sts to holder. With RS

facing, join yarn at right front neck edge. Work in patt across rem sts, ending at neck opening (center of left sleeve). CO 10 sts for button underlap. Keeping these 10 sts in k1, p1 ribbing and rem sts in patt, work right neck as for left neck, reversing shaping and ending at neck opening. (Do not shape back neck with short rows.) *Next row:* (WS) Place all held sts back onto needle—206 sts. *Dec row:* K3, *[p2tog] 1 (1, 0, 0) time(s), p0 (0, 2, 2), work 4 sts in patt, [p2tog] 1 (1, 0, 0) time(s), p0 (0, 2, 2), ssk, k2, k2tog; rep from *, end [p2tog] 1 (1, 0, 0) time(s), p0 (0, 2, 2), 2/2LC, [p2tog] 1 (1, 0, 0) time(s), p0 (0, 2, 2), k3, rib 10—142 (142, 168, 168) sts rem.

•**Finishing: Collar:** (WS) With shorter edging needle, rib 10, work 3 sts in St st, and beg with Row 1, work rem sts according to Collar chart. Cont in patt until collar measures 1½" (3.8 cm), ending with Row 4 of chart. BO 10 sts, p3, *k1 (1, 2, 2), [p2tog] 2 times; rep from *, end k1 (1, 2, 2), p3—88 (88, 116, 116) sts. *Turning*

Collar

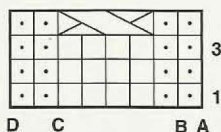

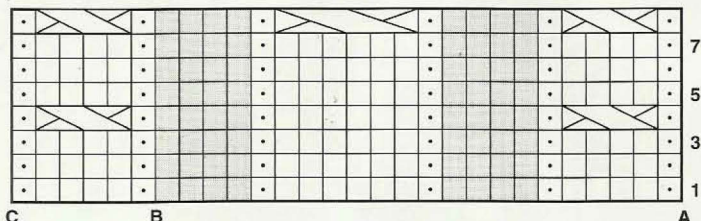

Small and medium sizes: Rep from B to C, end C to D.
Large and extra-large sizes: Rep from A to C, end C to D.

Sleeve and Yoke

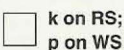
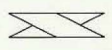

Yoke: Rep from A to B.
Sleeve: Rep from A to C.

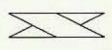
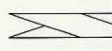
-  k on RS;
p on WS
-  p on RS;
k on WS
-  work as specified
-  2/2LC: sl 2 sts onto cn and hold in front, k2, k2 from cn
-  3/3LC: sl 3 sts onto cn and hold in front, k3, k3 from cn

Wrapping a Stitch

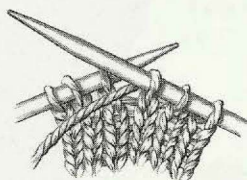

1. Work to turn point. Slip next stitch purlwise from the left needle to right needle and bring yarn to front.



2. Slip the same stitch back to the left needle.

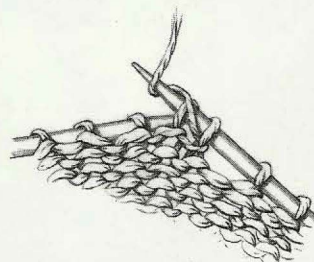

3. Turn work, bring yarn forward, and continue working across the row.

row: K3, p1 (1, 2, 2), *k2tog, yo, p1 (1, 2, 2); rep from *, end k3. Change to larger 16" (40 cm) needle, and beg with a purl row, work St st for 1½" (3.8 cm) for facing. BO all sts loosely. Turn facing to inside and sew loosely in place. Mark position of 4 buttons evenly spaced on underlap.

Buttonhole Band: With RS facing, join yarn at lower edge of neck opening. Work single crochet (sc; see Glossary, page 7) along side of neck opening, keeping work flat and working through both thicknesses. Ch 1, turn, sc in each sc, making a ch-3 loop opposite each button marking. Fasten off. Sew lower edge of underlap to inside of sweater. Sew on buttons. With yarn threaded on a tapestry needle, use Kitchener st (see Glossary, page 6) to join underarm seams. Weave in loose ends. Block. Sew beads between cable crosses as shown. ∞

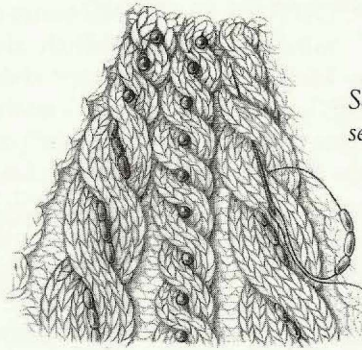

Sew 3 oval beads in the center of each large cable and sew 1 round bead in the center of each small cable.

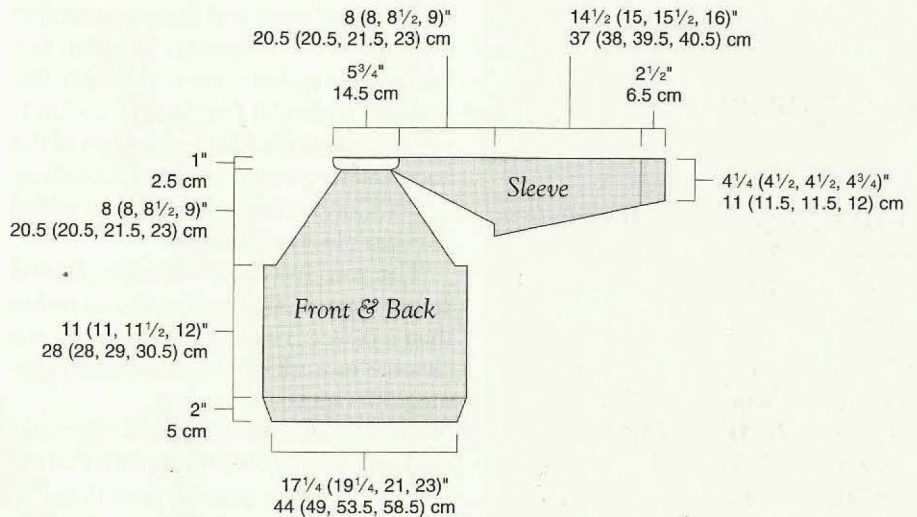

Diane Zangl is a freelance designer who works with national knitting magazines and yarn manufacturers. She believes in creating classic and attractive garments that can be enjoyed for many seasons. Diane lives in Wisconsin, where warm sweaters are a practical necessity.

NEW EXPANDED CATALOG FOR 1999

From

Beth Brown-Reinsel

Knitting Instructor, Author, Designer

Featuring:

- Imported Guernsey Yarns
- Wensleydale Wool Yarns
- New Sweater Patterns & Kits
- Toys, Tools, Gifts & Books
- Semi-Annual Newsletter with free patterns, product updates, techniques, & workshop schedule.

VISIT OUR WEB SITE

<http://members.aol.com/KnitTradit>

Download a free pattern • See new products

SEND FOR A FREE CATALOG TODAY!

Knitting Traditions

PO Box 421-I • Delta, PA 17314

(717) 456-7950

KnitTradit@aol.com



ROWAN yarns

A World Of Color At Your Fingertips

The Chenille Collection from Rowan

21 designs for men, women and children along with accessories for the home.

Featuring Rowan Fine and Chunky Chenille.

For the nearest fine shops carrying the Rowan Pattern books, yarn and knitting kits, please contact:

Westminster Fibers

5 Northern Boulevard

Amherst, NH 03031

(603) 886-5041

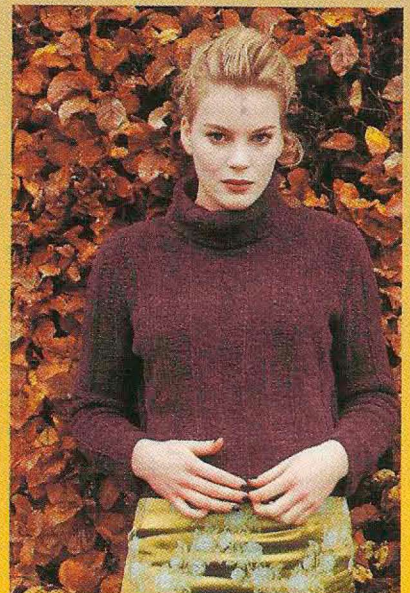

Hawk Sweater in Rowan Chunky Chenille by Kim Hargreaves



OPPOSITES ATTRACT

JUDITH L. SWARTZ

Couture styling

Contrasting embroidery

FINISHED SIZE 33 (35, 37, 39)" (84 [89, 94, 99] cm) bust/chest circumference, buttoned. Sweater shown measures 35" (89 cm).

YARN Plymouth Taj Mahal (70% extrafine Merino wool, 22% silk, 8% cashmere; 187 yd [170 m]/50 g): #1416 black, 3 (3, 3, 4) balls; #1401 white, 6 (6, 6, 7) balls.

NEEDLES Hem—Size 3 (3.25 mm); Body, Sleeves, and Collar—Size 4 (3.5 mm). Adjust needle sizes if necessary to obtain the correct gauge.

NOTIONS Markers (m); tapestry needle; eighteen $\frac{3}{8}$ " (1 cm) buttons.

GAUGE 24 sts and 32 rows = 4" (10 cm) in Pattern Stitch I on larger needles; 24 sts and 36 rows = 4" (10 cm) in Pattern Stitch II on larger needles.



Plymouth Taj Mahal
2-strand 4-ply; 14 wraps per inch

COUTURE KNITTING brings to mind detail work, which also brings to mind retro-inspired designs. While the embroidery details on this blouse are inspired by a vintage pattern from the 1940s, the finished product is a strong piece for any decade. The slim fit is decidedly modern, as is the black-and-white color contrast. The embroidery is easy—simply follow the purl stitches.

All pieces are worked from the bottom up. Stitches are decreased along the side seams to the waist and then increased to the full bust circumference. The front facings and buttonholes are worked simultaneously with the fronts; the collar is worked separately. The lower edges of the body and sleeves are hemmed for a clean finish. Contrasting embroidery is added after the pieces are knitted.

The yarn has the perfect weight and drape—fine enough to be a blouse rather than a jacket. The silk and cashmere is a pleasure to work with—it feels good running through your fingers.

Notes: To ensure that motifs align, use markers to designate repeats with Pattern Stitch II. To align patterns from sleeve to body, note where in the pattern the armhole shaping begins on the body and begin the sleeve shaping at the same point in the pattern. To keep edges smooth, all shaping is worked inside edge sts on RS as follows: dec rows—k1, ssk, work in pattern to last 3 sts, k2tog, k1. Inc rows—k1, M1, work in pattern to last st, M1, k1.

Stitches

Pattern Stitch I:

Row 1: (WS) Purl.

Row 2: (RS) Knit.

Rows 3–14: Rep Rows 1 and 2.

Rows 15 and 16: Purl.

Rep Rows 1–16 for pattern.

Pattern Stitch II: (multiple of 8 sts)

See chart, page 38.

Reverse Stockinette Stitch: (rev St st)

Row 1: (RS) Purl.

Row 2: Knit.

Rep Rows 1 and 2 for pattern.

•**Back:** With black and smaller needles, CO 109 (115, 121, 127) sts. Beg with a RS row, work 7 rows St st for hem. Change to larger needles. *Next row:* (WS) Knit to make turning ridge. Beg with Row 9, work edge st, Pattern Stitch I, then edge st, dec 1 st each end of needle every 6th row 9

times—91 (97, 103, 109) sts rem. Cont in patt until piece measures 7½ (8, 8, 8½)" (19 [20.5, 20.5, 21.5] cm) from turning ridge, or desired length to waist, ending with a RS row. Change to white. Work Rows 9–16 of Pattern Stitch I. Beg with Row 1, work Pattern Stitch II (beg as indicated for your size), inc 1 st each end of needle every 6th row 7 times, being careful to align Rows 6–10 over the previous motif (see chart)—105 (111, 117, 123) sts. Work even until piece measures 15½ (16, 16½, 17)" (39.5 [40.5, 41, 43] cm) from turning ridge, or desired length to armholes, ending with a WS row. **Shape armholes:** At beg of next 2 rows, BO 5 (6, 7, 8) sts. Dec 1 st each edge every other row 6 times—83 (87, 91, 95) sts rem. Cont in pattern until piece measures 22 (23, 23½, 24)" (56 [58.5, 59.5, 61] cm) from turning ridge, or desired length to shoulder, ending with a WS row. **Shape neck and shoulders:** Work across 27 (28, 29, 30) sts, join new yarn and BO center 29 (31, 33, 35) sts, and work to end. Working each side separately, BO 1 st at each neck edge 3 times, and *at the same time*, BO 8 sts at each shoulder edge 3 (2, 1, 0) time(s) and 9 sts 0 (1, 2, 3) time(s).

•**Left Front:** With black and smaller needles, CO 59 (62, 65, 68) sts. Work 7 rows of St st for hem. Change to larger needles. *Next row:* (WS) Knit to make turning ridge. Using the cable method (see Glossary, page 7), CO 7 sts—1 st for turning and 6 sts for facing. *Next row:* P6, k1, purl to end in Pattern Stitch I as for back. Working facing sts in St st and turning st in rev St st, work rem sts as for back, working decs and incs at arm edge until piece measures same as back to armhole—57 (60, 63, 66) body sts; 7 facing sts. **Shape armhole:** BO 5 (6, 7, 8) sts at armhole edge, then dec 1 st at armhole edge every other row 6 times—46 (48, 50, 52) body sts; 7 facing sts. Cont in patt until piece measures 20 (21, 21½, 22)" (51 [53.5, 54.5, 56] cm) from turning ridge. **Shape neck and shoulders:** At neck edge, BO 7 facing sts and 7 body sts (14 sts total), work to end of row. At neck edge on foll WS rows, BO 5 sts once, 3 sts once, 2 sts 1 (1, 2, 2) time(s), and then 1 st 5 (6, 5, 6) times—22 (23, 24, 25) sts rem, and *at the same time*, when arm edge measures same as back to shoulder, **shape shoulder:** at shoulder edge, BO 8 sts 3 (2, 1, 0) times and 9 sts 0 (1, 2, 3) time(s). **Mark button placement:** Mark placement of 18 buttons



in 9 groupings of 2 buttons each along center front edge so that first button is $\frac{3}{4}$ " (2 cm) above the first rep of Pattern Stitch I, last button is $\frac{3}{4}$ " (2 cm) below the neck shaping, and the other groups are spaced evenly between (allowing $\frac{1}{2}$ " [1.3 cm] between the 2 buttons in each group).

•**Right Front:** Work as for left front, reversing shaping and working double buttonholes opposite markers as follows: *Buttonhole row:* (RS) K2, yo, k2tog, k2, p1 (facing), k2, k2tog, yo, work to end of row. Work 3 rows in patt, then rep buttonhole row.

•**Sleeves:** With black and smaller needles, CO 49 (49, 53, 53) sts. Work hem and turning ridge as for back. Work Rows 9–16

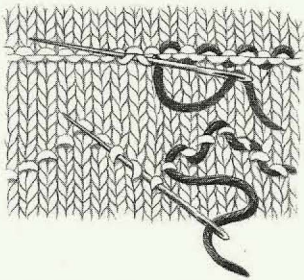

Work embroidery with contrast yarn.

of Pattern Stitch I. Change to white. Work Rows 9–16 of Pattern Stitch I. Change to Pattern Stitch II, inc 1 st each end of needle every 8 rows 16 (14, 14, 10) times and every 6 rows 0 (4, 6, 10) times—81 (85, 89, 93) sts. Cont in patt until sleeve measures 17 (18, 18, 18 $\frac{1}{2}$)" (43 [46, 46, 47] cm) from turning ridge, ending with same

row of pattern as for back before armhole shaping. **Shape cap:** At beg of next 2 rows, BO 5 (6, 7, 8) sts. Dec 1 st each end of needle every RS row 23 times—25 (27, 29, 31) sts rem. Cont even until cap measures about 5 $\frac{1}{4}$ (5 $\frac{3}{4}$, 5 $\frac{3}{4}$, 6)" (13.5 [14.5, 14.5, 15] cm). At beg of next 2 rows, BO 8 (9, 10, 11) sts. BO rem 9 sts.

Pattern Stitch II

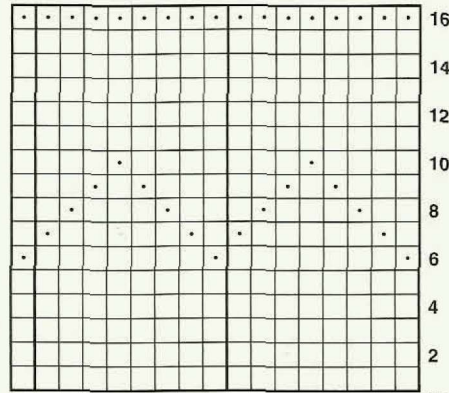

Note: Work edge st, then beg as indicated.

□ k on RS; p on WS

• p on RS; k on WS

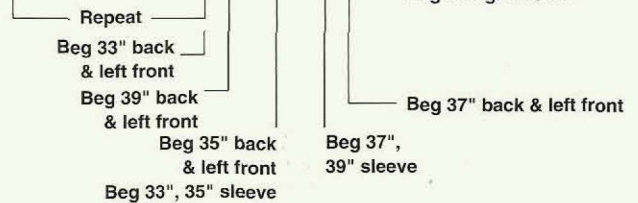

Schaefer Yarns

For Pattern #74 and samples send \$2.50 US to:
Schaefer Yarns
Kelly's Corners
Interlaken, NY
14847

EXTRAORDINARY HAND PAINTED FIBERS

CALL
1 ~ 800 FOR YARN (367 ~ 9276)
for the dealer nearest you.

FREE
Lion Brand Yarn Catalog

If you love yarn, don't miss this very special catalog! Filled with over 260 beautiful colors of yarn. Great gifts & kits to make for the holidays or just for fun!

For a copy of our catalog—just call, write or visit our website.

1-800-258-YARN(9276)
LION BRAND YARN COMPANY
34 W. 15TH ST., NY, NY 10011-4K
<http://www.lionbrand.com>

•**Collar:** With larger needles and white, CO 108 (112, 116, 120) sts. Knit 1 row. *Next row:* K2, M1, knit to last 2 sts, M1, k2. Rep these 2 rows until piece measures 1 3/4" (4.5 cm) from beg. With RS facing, change to black and knit 2 rows. BO all sts loosely.

•**Finishing:** With contrast yarn threaded on a tapestry needle and beginning and ending 1 st in from the edge, work embroidery on all purl ridges except turning ridges.

Note: Use even tension—if embroidery is too tight, the sweater will lose elasticity; if it is too loose, the yarn will catch and pull easily with wear. With yarn threaded on a tapestry needle, sew shoulder and side seams. Fold hems along turning ridges and stitch in place. Stitch around buttonholes, working both layers tog. Sew sleeve seams. Sew sleeve hem facing in place. Sew sleeves into armholes. Slipstitch collar to neck edge, aligning collar edges with inside of

front facing. Weave in all loose ends, taking care to weave ends of embroidery yarn into seam allowance wherever possible to avoid contrast yarn showing through on RS of work. Sew on buttons. Lightly steam hems and facings. ∞

Judith Swartz lives in Chicago where she manages the Weaving Workshop, teaches knitting and crochet classes, and designs and produces sweaters to grace the next millennium.

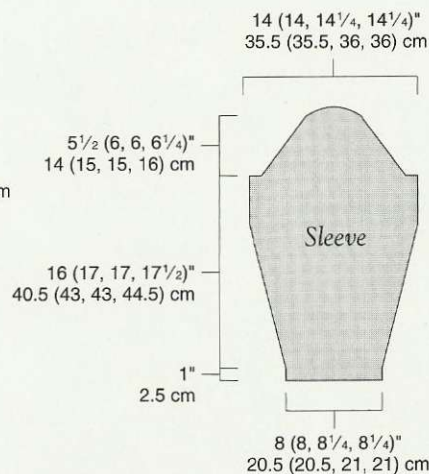
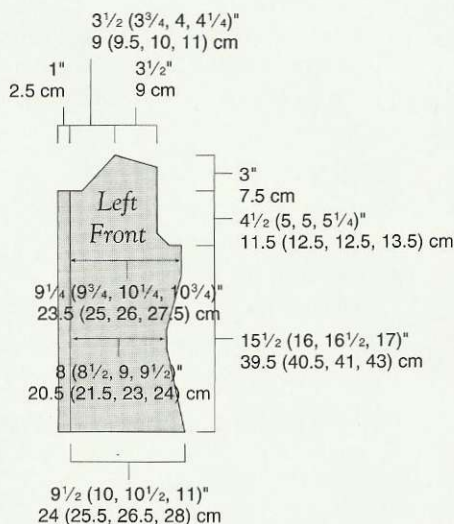
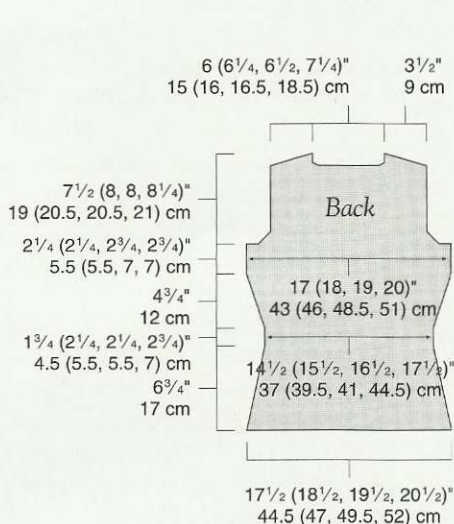

FREEDOM TO CHOOSE

Colors ♦ Yarns ♦ Patterns ♦ Styles

Whether you choose Lambs Pride or our new luxury Prairie Silk, Brown Sheep gives you the best in affordable natural fibers. For a list of shops near you that carry "Vivienne" and other Brown Sheep patterns and yarns, write to us at:

Brown Sheep Company
Dept IK98
100662 County Road 16
Mitchell, NE 69357



Brown Sheep Company — Your American Yarn Company.

A proud sponsor of Shay Pendray's Needlework Studio on Public Broadcasting



SIDEWAYS SEED JACKET

HÉLÈNE RUSH

Worked from side to side

Subtle color changes

FINISHED SIZE 39 (41 1/2, 44, 47)" (99 [105.5, 112, 119.5] cm) bust/chest circumference, buttoned. Sweater shown measures 39" (99 cm).

YARN Brown Sheep Prairie Silk (72% wool, 18% mohair, 10% silk; 88 yd [80 m]/50 g): #PS600 real royal, 6 (7, 8, 8) skeins; #PS400 ruble red and #PS250 krona coffee, 5 (6, 7, 7) skeins each.

NEEDLES Size 8 (5 mm). Adjust needle size if necessary to obtain the correct gauge.

NOTIONS Marker (m); tapestry needle; size J/10 (6 mm) crochet hook; five 5/8" (1.5 cm) buttons.

GAUGE 16 sts and 32 rows = 4" (10 cm) in seed st; 18 sts and 24 rows = 4" (10 cm) in St st.



Brown Sheep Prairie Silk singles; 12 wraps per inch

BEGINNING AT THE right center front, this seed-stitch jacket is worked sideways to the left center front in a subtle striped pattern. The lower scalloped edge is accentuated with a crocheted chain stitch. The sleeve cuffs are also worked sideways and stitches are picked up along the straight edge; the remainder of the sleeve is worked upward. The collar mimics the lower scalloped edging. The front openings are edged with crochet; twisted chain loops form the buttonholes.

The sheen in the yarn is highlighted by the textured seed stitch, and because the yarn is lightly spun, the resulting fabric is not too dense.

Stitches

Seed Stitch:

Row 1: *K1, p1; rep from *.

Row 2: Knit the purls; purl the knits.

Rep Row 2 for pattern.

Striped Pattern: *Work 2 rows each royal, red, coffee; rep from *.

Scalloped Edging: (worked in Seed st and Striped patt)

Row 1: (RS) Work even.

Row 2 and all WS rows: Work even.

Rows 3, 5, 7, and 9: Inc 1 st at end of row (lower edge).

Rows 11 and 13: Work even.

Rows 15, 17, 19, and 21: Dec 1 st at end of row (lower edge).

Row 22: Work even.

Rep Rows 1–22 for pattern, end with Row 2.

Crochet Chain Stitch: With crochet hook, royal, RS facing, and holding yarn under fabric and hook on RS of work, insert hook through fabric, pull up a loop, insert hook about 1/4" (6 mm) away, pull a second loop up and through first loop on hook. Cont in this manner, keeping even tension so fabric doesn't curl or draw in.

•Body: With royal, CO 68 (70, 72, 74) sts. Place m before last st on first row—67 (69, 71, 73) body sts; 1 edging st. *Note:* The edging sts are not included in body stitch counts unless otherwise indicated. Work body sts in Seed st and Striped patt, and edging st(s) in Scalloped Edging. Work even until piece measures 1 1/2 (1 3/4, 1 3/4, 2)" (3.8 [4.5, 4.5, 5] cm) from beg, ending with a WS row. **Shape neck:** (RS) Inc 1 st at neck edge every other row 4 times. Then CO 6 sts at beg of next RS row—77 (79, 81, 83) sts. Work even until piece measures 7 3/4 (8 1/2, 9, 9 3/4)" (19.5 [21.5, 23, 25] cm) from beg, ending with a WS row. **Shape armholes:** (RS) BO 26 (28, 30, 32) sts for front edge of armhole, work to end and mark this row on Scalloped Edging (to mark front edge of armhole). Dec 1 st at beg of each RS row 4 times—47 sts. Work even until piece measures 10 3/4 (11 1/2, 12, 12 3/4)" (27.5 [29, 30.5, 32] cm) from beg, ending with a WS row. Inc 1 st at beg of each RS row 4 times, marking last row on Scalloped Edging (to mark back edge of armhole). CO 26 (28, 30, 32) sts for back edge of armhole, work to end of row—77 (79, 81, 83) sts. Cont even until piece measures about 19 1/2 (20 3/4, 22, 23 1/2)" (49.5 [52.5, 56, 59.5] cm) from beg, ending at lower edge at the end (center, end, center) of a scallop. Mark this row for center back. Complete body to match half just completed, using marked rows as reference points for armhole shapings and reversing neck shaping—there will be 14 (15, 16, 17) scallops along the lower edge. BO all sts for left front edge.

•Sleeves: (Worked in Seed st and Striped patt as for body.) **Cuff:** With royal, CO 9 sts. Work even for 0 (2, 2, 4) rows, work Scalloped Edging 3 times, work Rows 1 and 2 again, then work even for 0 (2, 2, 4) more rows—68 (72, 72, 76) rows total. BO all sts. **Upper sleeve:** With royal and RS

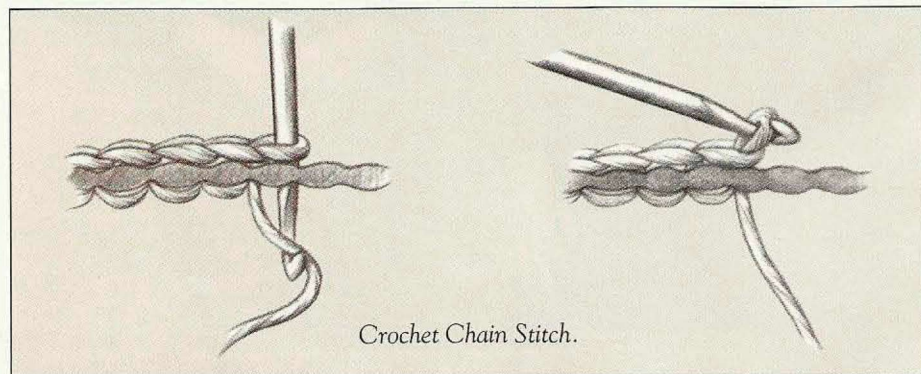

Crochet Chain Stitch.



THE Websters



HANDSPINNERS
WEAVERS
& KNITTERS

Alice Starmore
Rowan
FiestaYarns
Philosopher's Wool
Dale of Norway
Tahki
Brown Sheep
Vittadini
Creative Yarns
Manos
Cynthia Helene
Lorna's Laces
Mountain Colors
Stahl
Jo Sharp
Green Mountain
Berroco
Annabel Fox
Classic Elite
Prism
Noro
Crystal Palace
Froehlich

JO SHARP

PARADOX

from *West Cape Howe*
Cost of yarn
(large/53") \$150

Free COLOR CATALOG
1-800-482-9801
11 N. MAIN STREET
ASHLAND, OR 97520

facing, pick up and knit 46 (48, 50, 52) sts evenly spaced along straight edge of cuff. Beg with WS row, cont in Seed st and Striped patt to end of piece, and *at the same time*, inc 1 st each end of needle every 16 (14, 12, 12) rows 5 (6, 7, 4) times, then every 10 rows 0 (0, 0, 4) times—56 (60, 64, 68) sts. Cont even until piece measures 13¾ (14¼, 14¼, 14¾)" (35 [36, 36, 37.5] cm) from pick-up row, ending with a WS row. **Shape armhole and cap:** At beg of next 2 rows, BO 4 sts. Then dec 1 st each end of needle every 4 rows 6 times, then every 2 rows 8 (10, 12, 14) times—20 sts rem. At beg of next 6 rows, BO 2 sts. BO rem 8 sts.

•**Collar:** With royal, CO 9 sts. Work even for 0 (2, 2, 4) rows, work Scalloped Edging 8 times, work Rows 1 and 2 again, then work even for 0 (2, 2, 4) more rows—178 (182, 182, 186) rows total. BO all sts.

•**Finishing:** With royal, work 1 row Crochet Chain Stitch 1 st in from lower edge of collar and sleeves, following scalloped shape. **Body edging:** Mark placement of 5 button loops on right front—one ½" (1.3 cm) down from neck edge, one about 1½" (3.8 cm) up from lower edge, and the others evenly spaced between. Beg at left neck edge, work 1 row slip st (sl st) crochet in back loop only down BO edge of left front edge, then work Crochet Chain Stitch around scallops along lower edge as for sleeves and collar, then sl st up CO edge of right front, to first m, [ch 10, work sl st to next m] 4 times, ch 10, sl st to neck edge. Fasten off. Beg at left front neck and working in back loop only of previous sl st row, work 1 more sl st row down to lower edge. Fasten off. Beg at lower right front edge and working in back loop of each sl st, [sl st to ch-10, twist ch-10 loop clockwise by half a turn, skip first ch, sl st in next 9 ch of loop] 5 times, sl st to neck edge. Fasten off. **Loop embroidery:** With royal, work Crochet Chain Stitch along lower edges of body, sleeves, and collar, working a continuous loop pattern that curls clockwise in the center of each scallop, and leaving 3 sts between edge Crochet Chain Stitch row and rounded edge of curl, and working flat portion (top) of loop pattern bet 7th and 8th st from edge. (It may help to work a basting row with a contrasting color yarn bet 8th and 9th st as a guide.) Ease collar around neck opening and sew in place. With yarn threaded on a tapestry needle, sew shoulder and underarm sleeve seams. Work Crochet Chain Stitch on each sleeve where cuff meets sleeve. Sew sleeve caps into armhole openings easing in fullness. Weave in loose ends. Sew buttons opposite button loops. ∞

The Finest Original Woven Labels Since 1846

100% WOVEN

Heirloom Woven Labels

ACTUAL SIZE 1½" WIDE

A *Panda Jane Snow* B *An Original by Amy Harrington* C *The Glass Dragon Hand Crafted Bears*
D *The Free House* E *NANCY JOHNSON* F *Linda Fuller Silver*

1. **LETTERING** Circle style desired above.

2. **MOTIFS** Circle choice. Not available with style E or F.

3. **COLORS** Circle one for lettering, one for background below.

6. **PRICING**

LETTERING	LABEL BACKGROUND	36 labels for \$21.00
RED, GOLD LUREX	ON WHITE, CREAM, GREY, BLACK, GREEN, NAVY	72 labels for \$27.50
GREEN, GOLDENROD	ON WHITE, CREAM, BLACK	144 labels for \$40.00
WHITE, GOLD LUREX	ON GREY, ROSE, SKY, LILAC, BLACK, GREEN, NAVY	NJ Residents add 6% tax
BLUE, BROWN, BLACK, PINK	ON WHITE, CREAM	Postage and Handling \$ 2.95
		US currency only TOTAL \$

4. **LABEL INFORMATION** PLEASE PRINT

Line One _____ Allow 3-4 Weeks for delivery

Line Two _____

MAXIMUM 24 letters and spaces per line

5. **CUSTOMER INFORMATION** Mail to: HEIRLOOM WOVEN LABELS
P.O. BOX 428 IK798
Moorestown, N.J. 08057

Send labels to:

Name _____ Phone Orders now accepted
(609) 722-1618
Address _____ FAX (609) 722-8905
http://members.aol.com/heirlooml
Phone _____

MasterCard VISA

Hélène Rush designs and publishes knitwear patterns from her home in Windham, Maine.

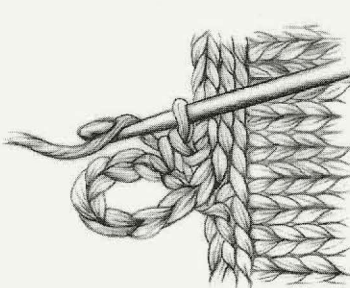

Twist chain-10 loop clockwise by half a turn, slip stitch into remaining chains of loop.

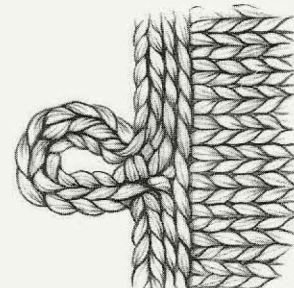

Finished buttonhole.

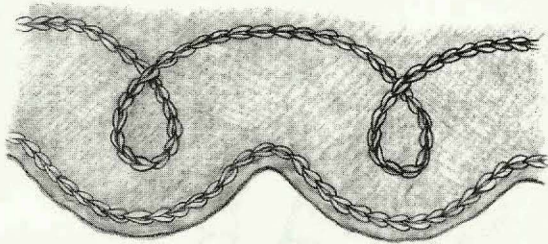

Work Crochet Chain Stitch one stitch in from scallop edge.
Work Crochet Chain Stitch in loop pattern that curls clockwise in the center of each scallop.

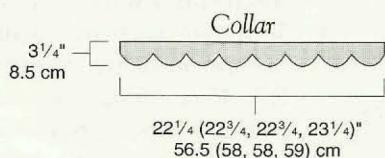
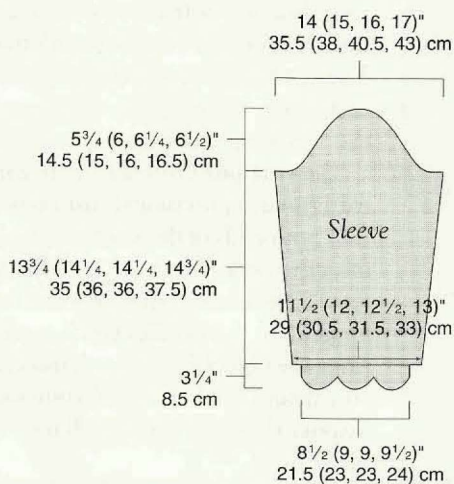
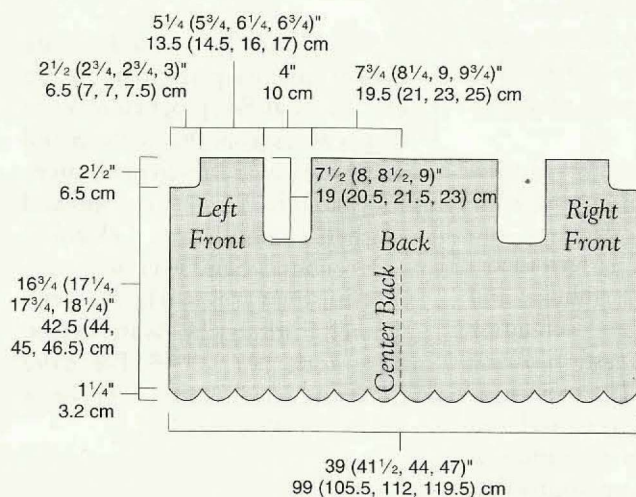

Have some fun with

Interweave

Knits

Knitting's never a grind with *Interweave Knits*. Every project in the magazine is clearly illustrated to help you succeed. Designs are inspirational, sometimes classic, sometimes contemporary, always exciting.

And you get a **BONUS** with your subscription. Twice a year, a special subscriber newsletter features projects by staff and readers, plus lots of *your* news about knitting. To make sure you receive *Interweave Knits* and your free newsletters, subscribe or renew today.



\$24 (1 yr, U.S.)

800-645-3675

Dept. A-KB



INTERWEAVE PRESS

201 East Fourth Street Loveland, CO 80537-5655

<http://www.interweave.com>

The *Elegant* SEAMEN'S SCARF

Myrna A. I. Stahman

Based upon Anchored Within the Vail: A Pictorial History of the Seamen's Church Institute by Leah Robinson Rousmaniere.

ONE HUNDRED YEARS ago, during the Spanish-American War, a wonderful tradition was born. Through the efforts of a concerned citizen and a military chaplain, a program which now involves more than 3,000 knitters and serves more than 13,000 seamen began.

The Reverend Walter A. A. Gardner, chaplain of the North River Station (located in what is now downtown Manhattan, New York), noted in his annual report of 1898 that a Mrs. E. A. Gardner "conceived the idea of supplying 'our' warships with 'just what they needed.'" As a result, "Noble-hearted friends came to her assistance. The New York Herald and the Associated Press took it up, and thousands of (comfort) bags, medical supplies, delicacies, Bible prayer books, testaments, and many cases of literature were sent to our men." The seeds of the current "Christmas-at-Sea Program" were planted, and soon the Seamen's Benefit Society, a ladies' auxiliary of the Seamen's Church Institute of New York and New Jersey, was established. One of the many functions of this auxiliary was to provide knitted pieces to the seafarers who stopped at the Institute.

By 1941, about 2,000 volunteers, including many from churches of all denominations throughout the United States, provided about 5,000 gift boxes containing handknit sweaters, socks, hats, mittens, and scarves. These gifts were distributed by volunteers of the Seamen's Church Institute to the crews of freighters and tankers who spent Christmas Day at

sea. In 1996, about 17,000 garments, including 6,000 scarves, were knit by nearly 3,000 volunteer knitters and given to merchant mariners who were at sea on Christmas Day.

The Christmas-at-Sea program provides volunteer knitters with patterns for knitting scarves, watch caps, sweaters, and socks. The seamen's scarf pattern incorporates garter stitch and ribbing, and makes a wonderfully warm and well-fitting muffler. This classic scarf is easily mastered by the beginning knitter. The pattern, as provided by the program, is reproduced below. I was inspired to use this pattern as the basis for the following patterns that combine beautiful lace and luxury fibers.

ORIGINAL SEAMEN'S SCARF PATTERN

(provided to volunteer knitters by the Seamen's Church Institute)

Materials:

4-ply yarn: one scarf takes 4½ ounces

Pair No. 6 needles

Wool needle for joining yarn and finishing garment

Gauge:

5 sts = 1", 7 rows = 1" (Garter St)

IMPORTANT: CHECK GAUGE

Cast on 32 sts with medium tension. Knit even for 14 inches. K4, P4 for 18 inches. K even for 14 inches. Bind off with medium tension. *Note:* Measurement of completed scarf: Approx. Width 6½"; Length 46".

PLEASE DO NOT BLOCK SCARF

The Seamen's Church Institute invites you to participate in its Christmas-at-Sea program by knitting scarves from this pattern and matching watch caps from a pattern they provide. Washable wools and synthetics in bright and dark colors are requested. Send your donations to: Christmas at Sea, The Seamen's Church Institute, 241 Water Street, New York, NY 10038. For more information call Barbara Clausen at (212) 349-9090 ext. 257.

FIVE LACE SCARVES IN LUXURY FIBERS

Below are instructions for five luxury scarves knitted in the seamen's tradition. The scarf pattern was the inspiration for each of the beautiful lace patterns. All use the following techniques.

Casting on: On each scarf with lace patterning, a provisional cast-on is used so that both ends of the scarf may be knitted from the neck downward and the lace patterns appear balanced. Use a crochet hook larger than the needles you'll use for knitting (size G/6 [4.25 mm] will usually work) and about 2 yards (2 m) of waste yarn a bit heavier than the yarn you'll use (I use 4-ply cotton).

With the crochet hook and waste yarn, crochet a chain of about 6 stitches more than you'll need to cast on. Pull the last stitch through the loop to fasten it off. Turn the crocheted chain so that the "bumps" are on top (facing you). Leave an 18" (46-cm) long "tail" of scarf yarn and pick up stitches from the chain by inserting the knitting needle into the first bump

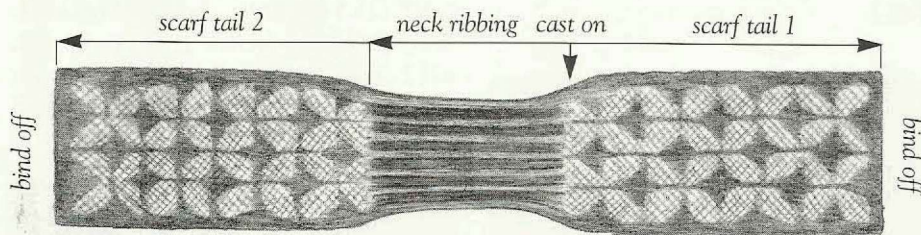

Schematic of basic seamen's scarf.

and picking up a stitch with the scarf yarn. Continue in this manner until you have the number of stitches specified in the pattern. Properly done, this cast-on is removed by "unzipping" like the top of a sugar or feed sack.

Selvedges: For even selvedges, slip the first stitch of every row purl-wise (holding the yarn in front of the needle) and knit the last stitch of every row.

Borders: A six-stitch border of seed stitch is worked around the lace portions of each scarf. At the beginning of a row, this is worked as follows: Sl 1 pwise, [k1, p1] 2 times, k1. At the end of a row, it is worked: [k1, p1] 2 times, k2.

Neck ribbing: The neck portion (center) of the scarf is made up of 10" (25.5 cm) of ribbing. It is begun by taking out the provisional cast-on and picking up the live stitches, and is worked in the opposition direction. Most scarves have a k4, p4 ribbing, but slight adjustments have been made on some to accommodate the number of stitches needed for the lace patterns.

Binding off: All of the scarves use the Icelandic bind-off which gives a very nice, somewhat stretchy, bind-off edge. It is worked with a needle about two sizes larger than used for the scarf. *Insert the larger needle (held in your right hand) through the first stitch on the left-hand needle, knit through the front loop of the second stitch, and slip both stitches off the needle, leaving one stitch on the right-hand needle. Keeping this stitch comfortably loose, slip it back onto the left-hand needle and repeat from *. With very little practice this becomes a single step—knitting the second stitch on the left needle through the first stitch and dropping it off.

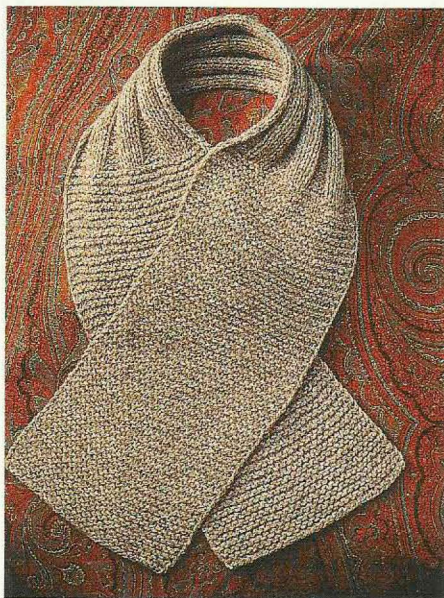

I. J.

I designed this scarf in memory of my father "I. J." It is a slight modification of the seamen's scarf and is worked from one end to the other.

Finished size: About 7½" (19 cm) wide by 48" (122 cm) long.

Yarn: Haneke Select (75% Merino wool, 25% alpaca, 2-ply medium weight; 130 yd [119 m]/2 oz): cocoa, 2 skeins.

Needles: Size 9 (5.5 mm) or size necessary to obtain the desired gauge.

Gauge: 14 sts and 22 rows = 4" (10 cm) in garter st.

CO 30 sts. *Slipping the first st of every row pwise (hold the yarn in front as you slip), work garter st (knit every row) until piece measures 16" (40.5 cm) from beg *.

Neck ribbing:

Row 1: Sl 1 pwise, *k4, p4; rep from *, end k5.

Row 2: Sl 1 pwise, *p4, k4; rep from *, end last rep p4, k1.

Rep Rows 1 and 2 for 15" (38 cm). Change to garter st, slipping the first st of every row pwise until garter-stitch section measures 16" (40.5 cm) from end of ribbing. Using the Icelandic method, BO all sts.



MARIALIS II

This scarf uses the Feather and Fan stitch, also known as Old Shale.

Finished size: About 9" (23 cm) wide by 51" (129.5 cm) long.

Yarn: Haneke Select (75% Merino wool, 25% kid mohair, fingering weight; 256 yd [234 m]/2 oz): creme, 2 skeins.

Needles: Size 8 (5 mm) or size necessary to obtain the desired gauge.

Gauge: 24 sts and 32 rows = 4" (10 cm) in ribbing patt.

Using the provisional method, CO 46 sts. **Scarf Tail 1:** Following chart, work Set-up Row 1 and Set-up Row 2 (inc 2 sts as indicated)—48 sts. Work Rows 1–4 of chart 28 times, or until piece measures about 18" (46 cm) from beg, ending with Row 4 of chart. **Border:** (worked in seed st) Work Dec Row as charted—43 sts rem. Cont to end of chart, working a total of 8 rows for border. Using the Icelandic method, BO all sts.

Neck ribbing: Carefully remove the provisional CO, placing live sts onto needle as they are released from the waste yarn—46 sts. Beg by using the 18" (46-cm) CO tail and join new yarn when about 6" (15 cm) of the tail rem.

Row 1: (RS) Sl 1 pwise, *k4, p4; rep from * to last 5 sts, k5.

Row 2: Sl 1 pwise, *p4, k4; rep from * to last 5 sts, p4, k1.

Rep Rows 1 and 2 for 10" (25.5 cm), ending with Row 2.

Scarf Tail 2: Beg with Set-up Row 1, work as for Scarf Tail 1.



GRACIE

A variation of "Bernadin's Sampler Pattern No. 5", from *The Lacy Knitting of Mary Schiffmann* by Nancy Nehring (Interweave Press, 1998).

Finished size: About 9" (23 cm) wide and 48" (122 cm) long.

Yarn: Creature Comforts (15% chinchilla, 75% Merino wool, 10% silk, fingering weight; 515 yd [471 m]/4 oz): natural gray, 1 skein.

Needles: Size 6 (4 mm) or size necessary to obtain the desired gauge.

Gauge: 20 sts and 24 rows = 4" (10 cm) in St st.

Using the provisional method, CO 37 sts. **Scarf Tail 1:** *Set-up Row 1:* (RS) K2, [p1, k1] 2 times, pm, k25, [k1, p1] 2 times, k2. *Set-up Row 2:* Sl 1 pwise, [k1, p1] 2 times, k1, p25, [k1, p1] 2 times, k2. Work the first 6 sts according to Seed Stitch I chart, the last 6 sts according to Seed Stitch II chart, and the center 25 sts according to Center Lace chart. Work in patt until Rows 1–16 of Center Lace chart have been worked 6 times (purl even-numbered rows). Keeping first and last 6 sts in established seed st, work center 25 sts in St st for 2 rows. **Border:** (worked in seed st) *Rows 1–8:* Sl 1 pwise, *k1, p1; rep from *. Using the Icelandic method, BO all sts. **Neck ribbing:** Carefully remove the provisional CO, placing live sts onto needle as they are released from the waste yarn—37 sts. Beg by using the 18" (46-cm) CO tail and join new yarn about 6" (15 cm) of the tail rems.

Row 1: Sl 1 pwise, [k4, p4] 2 times, k3, [p4, k4] 2 times, k1.

Row 2: Sl 1 pwise, [p4, k4] 2 times, p3, [k4, p4] 2 times, k1.

Rep Rows 1 and 2 until the neck ribbing is 10" (25.5 cm) long, ending with Row 2.

Scarf Tail 2: *Set-up Row 1:* Sl 1 pwise, [k1,

p1] 2 times, k1, k25, [k1, p1] 2 times, k2. Begin with Set-up Row 2, work as for Scarf Tail 1.

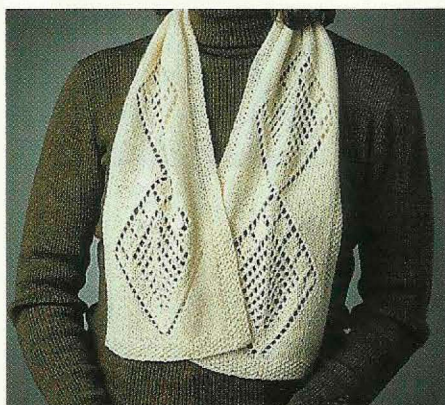

KATHLEEN

Based on a design from a sampler in the Brooklyn Museum, charted by Susanna E. Lewis in *Knitting Lace, A Workshop with Patterns and Projects* (Taunton, 1992).

Finished size: About 8" (20.5 cm) wide and 41" (104 cm) long.

Yarn: Haneke Heaven Sent (100% baby royal alpaca; 200 yd [183 m]/50 g): #10 natural, 2 balls.

Needles: Size 4 (3.5 mm) or size necessary to obtain the desired gauge.

Gauge: 24 sts and 29 rows = 4" (10 cm) in St st.

Using the provisional method, CO 45 sts. **Scarf Tail 1:** *Set-up Row 1:* (RS) K2, [p1, k1] 2 times, pm, k33, pm, [k1, p1] 2 times, k2. *Set-up Row 2:* Sl 1 pwise, [k1, p1] 2 times, k1, p33, [k1, p1] 2 times, k2. Work first 6 sts according to Seed Stitch I chart, last 6 sts according to Seed Stitch II chart, and center 33 sts according to Center Lace chart. Work in patt until Rows 1–52 of Center Lace chart have been worked 2 times (purl even-numbered rows). Keeping the first and last 6 sts in established seed st, work center 33 sts in St st for 2 rows. **Border:** (worked in seed st) *Rows 1–8:* Sl 1 pwise, *k1, p1; rep from *. Using the Icelandic method, BO all sts. **Neck ribbing:** Carefully remove the provisional CO, placing live sts onto needle as they are released from the waste yarn—45 sts. Beg by using the 18" (46-cm) tail and join new yarn with about 6" (15 cm) of tail rems.

Row 1: Sl 1 pwise, [k4, p4] 2 times, k4, p3, k4, [p4, k4] 2 times, k1.

Row 2: Sl 1 pwise, [p4, k4] 2 times, p4, k3,

p4, [k4, p4] 2 times, k1.

Rep Rows 1 and 2 until the neck ribbing is 10" (25.5 cm) long, ending with Row 2.

Scarf Tail 2: *Set-up Row 1:* Sl 1 pwise, [k1, p1] 2 times, k1, k33, [k1, p1] 2 times, k2. Begin with Set-up Row 2, work as for Scarf Tail 1.

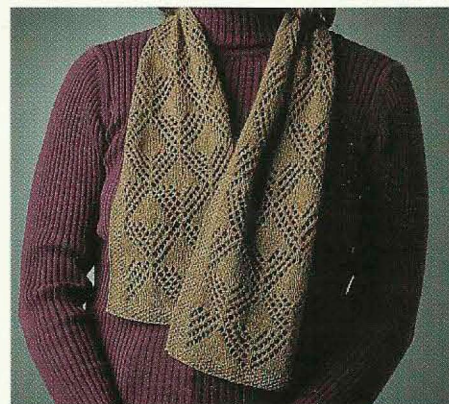

CATHARINA

A variation of "Smiling Diamonds" from *A Treasury of Knitting Patterns* by Barbara Walker (Schoolhouse Press, 1998).

Finished size: About 8" (20.5 cm) wide and 45" (114.5 cm) long.

Yarn: The Musk Ox Farm (100% musk ox qiviut; 300 yd [274 m]/1 oz): natural brown, 1 skein.

Needles: Size 2 (2.75 mm) or size necessary to obtain the desired gauge.

Gauge: 36 sts and 36 rows = 4" (10 cm) in ribbing patt.

Using the provisional method, CO 49 sts. **Scarf Tail 1:** *Set-up row:* (WS) K2, [p1, k1] 2 times, pm, p37, [k1, p1] 2 times, k2. Work first 6 sts according to Seed Stitch I chart, last 6 sts according to Seed Stitch II chart, and center 37 sts according to Center Lace chart. Work in patt until Rows 1–36 of Center Lace chart have been worked 4 times (purl even-numbered rows). **Border:** (worked in seed st) *Rows 1–8:* Sl 1 pwise, *k1, p1; rep from *. Using the Icelandic method, BO all sts. **Neck ribbing:** With WS facing, carefully remove the provisional CO, placing live sts onto needle as they are released from the waste yarn—49 sts. Beg by using the 18" (46-cm) tail and join new yarn with about 6" (15 cm) of tail rems.

Row 1: (WS) Sl 1 pwise, [p4, k4] 2 times, [p3, k3] 2 times, p3, [k4, p4] 2 times, k1.

Row 2: Sl 1 pwise, [k4, p4] 2 times, [k3, p3] 2 times, k3, [p4, k4] 2 times, k1.

Marialis II

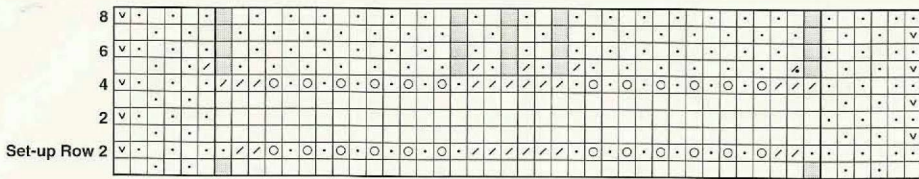

- Work 3 times for border
 - Dec row
 - Work 28 times
 - Set-up Row 1
 - Set-up Row 2
 - Set-up Row 1
 - Set-up Row 2
- k on RS; p on WS
 - p on RS; k on WS
 - yo
 - sl 1, k2tog, pss0
 - sl 1 pwise
 - ssk
 - k2tog
 - no stitch
 - p2tog

Kathleen Center Lace

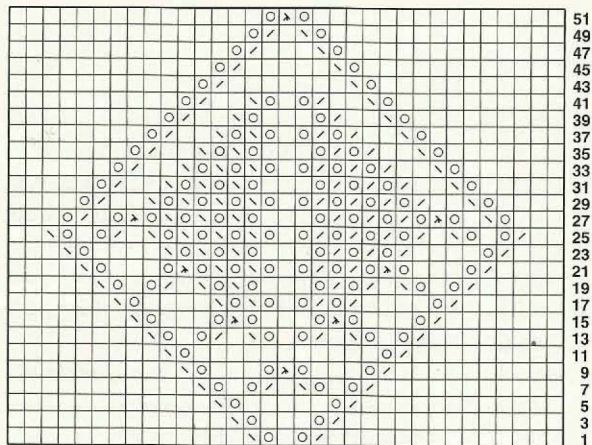

Purl even-numbered (WS) rows.

Catharina Center Lace

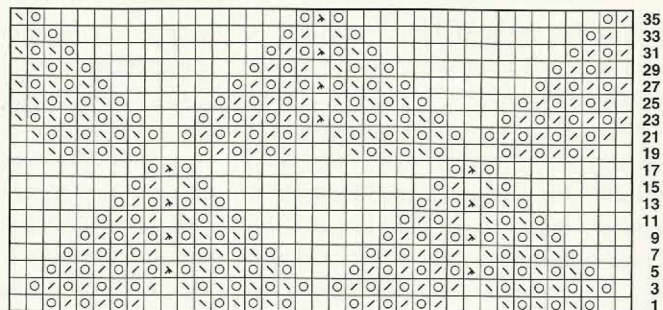

Purl even-numbered (WS) rows.

Gracie Center Lace

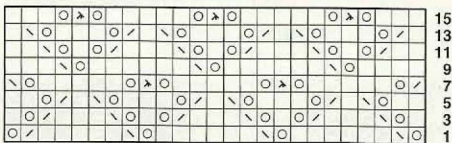

Purl even-numbered (WS) rows.

Seed Stitch I

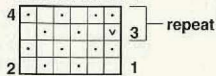

Seed Stitch II



Rep Rows 1 and 2 until the neck ribbing is 10" (25.5 cm) long, ending with Row 2.
Scarf Tail 2: Set-up row: (WS) Sl 1 pwise, [k1, p1] 2 times, k1, p37, [k1, p1] 2 times, k2. Beg with Row 1 of Center Lace chart, work as for Scarf Tail 1.

A life-long pleasure knitter, Myrna A. I. Stahman lives in Boise, Idaho, where she now enjoys designing Faroese-shaped lace shawls, lace scarves, and afghans. Her knitting needles accompany her everywhere she goes, including into the courtroom where she observes the attorneys she supervises. In her "spare" time, Myrna works on her "soon to be published" book of Faroese-shaped lace shawls.

Free Knitting Kit Catalog
 Call Now 1-800-523-WOOL

Haneke Heaven Sent

Yarn has arrived.

For your next special project you must try this very exclusive, special select, baby alpaca yarn. It sets the new standard for alpaca fiber!

Remember our Kit Catalog features our famous selection of Merino, Alpaca and wool yarn blends. We now offer a wide range of looms, knitting machines, spinning wheels and related accessories. Call and visit with us about your fiber art needs.

Haneke Wool Fashions
 630 North Black Cat Road
 Meridian, Idaho 83642
 Sample cards available
 Satisfaction guaranteed

HANDKNITS

Susan Guagliumi

by Machine

I'VE BEEN A MACHINE KNITTER and instructor for more than sixteen years, and although machines and sweater styles have both changed, two questions are constant: "Where can I find good machine-knit patterns?" and "How can I use handknit patterns on the machine?" So far machine-knit magazines and pattern books have tended to highlight garments that are quite unlike those we find in handknit publications. Why? Probably because knitting-machine technology is so fascinating that designers concentrate on what machines can do, rather than on fashion. A machine's creative possibilities are endless, but creative is not necessarily the same as fashionable.

For years, standard-gauge machines ruled the market, and because they use only fine-weight yarns (usually coned) it wasn't very practical to think of them for handknit designs. Machine knitting traveled a parallel, but separate course from handknitting until mid- and chunky-gauge machines appeared on the scene. Then things began to change. These new machines knit DK, worsted, and Aran weights as well as a whole range of novelties—the very stuff that fills the pages of many knitting magazines. Machine knitters have come to understand that they don't need to have their yarns on cones (although it is certainly convenient when they are!) and have found a whole new source for materials and designs.

Not all handknit designs can be produced on a machine, but more can than can't. Sometimes it's possible to exactly duplicate a design by machine, other times you'll need to make changes to accommodate the machine's (or your) capabilities. In this article I'll outline my approach to knitting a handknit design on the machine.

Start by taking a good long look at the photograph of the garment. After all, that's

what peaks our interest to begin with! If it is knitted in stockinette, Fair Isle, mosaic, intarsia, Shaker ribs, twisted or traveling stitches, or short rows, chances are you can knit the entire garment on a machine with very few changes. Be on the lookout for knit/purl combinations like seed and moss stitch, traveling cables with purl stitch backgrounds, and garter stitch. These stitches will require some adjustment or modification for the machine.

Because all the needles on a machine's bed face in one direction, all the stitches they produce also face in one direction—i.e., purl stitches face you, knit stitches face away. In order to have both knit and purl stitches on one side of the fabric, you need to reform stitches manually with a latch tool. When there are lots of reversed stitches to deal with, a second bed of needles (a ribber bed) is best. While reforming is an easy solution for placing a purl stitch alongside a cable or two, a ribber automatically produces lots of cables or all-over ribbed fabric. Remember that a stitch on one bed or the other usually remains on that bed and continues as either a knit or a purl throughout the fabric. In order to have a stitch appear as a knit in one row and a purl in the next, you have to intervene and either rework that stitch after each row is knitted or transfer stitches from one bed to the other. For isolated bits of texture this procedure really isn't a problem, but reforming an entire sweater to make seed stitch just isn't practical. By the same token, while garter stitch is a snap for handknitters, it is time-consuming and clumsy to produce on the machine because you have to remove the work, turn it over, and return it to the needles after each row is knitted. With the exception of the plastic hobby machines, all current knitting machines are available with ribbers, and whether or not you have one will

help define the range of sweaters you can practically knit on your machine. Some standard-gauge machines have a garter carriage for producing knit/purl stitch combinations, but none is available for the mid-gauge or chunky models you would be most likely to use for duplicating handknit looks.

Very often I find that I can exactly reproduce a design if I'm willing to do some handwork on the machine or a little handknitting. The intarsia sweater shown below calls for seed stitch detailing, and since it adds so much to the design, I would reform those stitches after each row was knitted. This past summer I knitted a great little

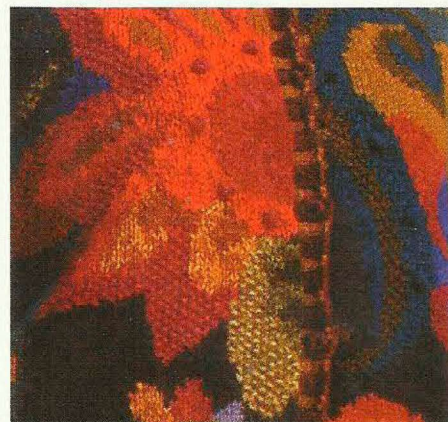

top from the new Tahki book. It has garter-stitch borders around the armholes and at the lower edge. I reformed the few garter stitches along the armhole edges as I knitted the pieces, but decided it would be much easier to knit the six-inch garter-stitch border at the lower edge by hand. To streamline the look, I knitted that border after sewing the side seams so I could pick up all the lower-edge stitches and avoid seaming the garter stitch.

Sometimes it isn't possible to exactly duplicate a texture or effect and you have to substitute something more practical for the



machine. I'm intrigued by the currently-popular domino knitting (also called number knitting and patchwork knitting) shown above, and know that when I get around to trying the method I'll work in stockinette rather than garter stitches. The method of working one piece off the last is the same by hand or machine, and with careful color choices and occasional rows of garter or other hand-manipulated textures, I'll be able to knit something equally interesting, though not an exact duplication.

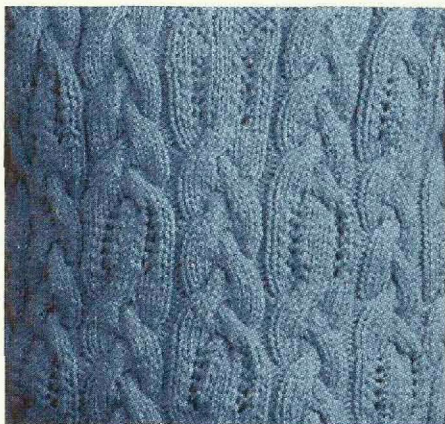

Purl stitches in cable designs are a little trickier to understand. The cables shown above are flanked on each side by two purl stitches. These can be knitted on a single-bed machine with the purls latched up, although a ribber would streamline the process. Cables that pose problems on the machine are the ones that travel extensively, so that a stitch is knitted on one row and purled on the next. Some of these can be knitted as double-bed cables, but you need to travel stitches on both beds, making new stitches and decreasing others to accommodate the traveling. Not beginner cables, these are challenging and interesting knitting for someone with good double-bed experience.

Mosaic knitting is easy and fun to do on the machine. Most machine knitters knit these designs in two-color tuck, but you can also knit them in slip as hand-knitters do. Small isolated designs can be "hand pulled" on simple machines, but all-over designs like the one shown below would be best knitted on an electronic machine. You cannot work from a chart writ-



ten for handknitting; you need to convert it to an electronic design card. Working with one full vertical and horizontal repeat of the pattern, make a new chart that records the actual needle selection for each row. Disregard the fact that each row is knitted twice; that will be taken care of once you have your chart. I've renumbered the original chart rows one through twenty to make the conversion clearer. For Row 1 (and all odd-numbered rows) fill in the black squares of the chart. For Row 2 (and all even-numbered rows) fill in the white squares. Set the machine to knit each row of the design card twice and knit two rows per color in tuck or slip.

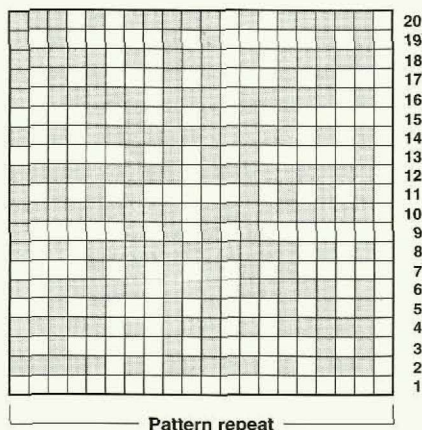

This chart shows one repeat and has the original rows re-numbered 1–20.

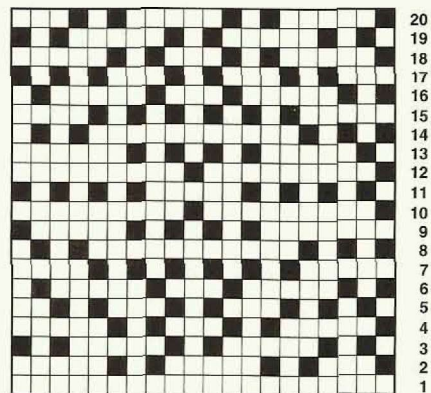

This chart shows the electronic design card for the same pattern. Although it doesn't look very much like the original chart, the knit fabric will be identical.

Designs like the one shown here should look familiar to most machine knitters. Known as "card #3", the design tucks every fourth stitch for four rows, then the alternate fourth stitches for the next four rows.



Changing colors every four rows creates the diamond shaped lozenges of color. This stitch is a snap on all machines—even manual models.

In multicolor and mosaic tuck or slip stitches, the knit side is the right side, while the right side of machine-knit one-color tuck and slip stitches is the purl side. Keep this in mind when evaluating one-color slip-stitch designs. The slips are always on the purl side of a machine-knit fabric. The only way to place a slip stitch on the knit side is to manually remove the previous stitch from its needle, catch the slip in front of the stitch, and then return the stitch to the needle. For scattered effects this works fine, but it is not practical for large designs.

The cardinal rule of machine knitting is: *The stitch that is on a needle first will*

always show on the knit side. This is especially important when you're duplicating slip stitches, cables, and lace designs from charts that represent the knit side of the fabric. If all the cables in a sweater cross the same way, it often won't matter whether they cross left or right. However, when a design features cables crossing in both directions and interlacing with each other, it is essential to heed the direction each cable crosses. A cable cross on a chart usually looks something like this one: it has a solid line with a broken line underneath it; the solid line represents the

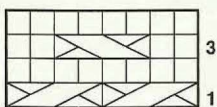

stitches that cross in front. By machine, these are the stitches that return to their needles first.

Lace designs like the one shown below are easy to knit on a machine by hand-transferring stitches or using a lace carriage (available for standard-gauge machines only). Lace patterns knitted in garter stitch are generally not suitable for machines,

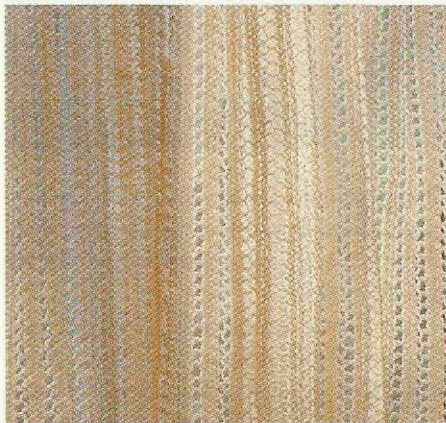

nor are those with lots of purl stitches sprinkled throughout. Remember that the purl side of the work is facing you, rather than the knit side, and that some decreases must be made in two steps to keep the same face stitch throughout a design. For example, instead of moving three stitches over by one needle you should first move the fourth stitch to the third needle and then move all three. In some designs you needn't bother, but in many designs the

slant of the face stitch is a major design component and the pattern will not look right without it. Always try a sample first so you are not disappointed.

Once you've evaluated the way the garment looks, start reading through the directions for the specifics of gauge and construction. The yarn and the recommended gauge determine which machine to use. Standard-gauge machines have 200 needles and generally knit fingering, fine sport, baby, and dress-weight yarns, although you can work on every other needle to expand that range. Just remember that when you work on every other needle (on any machine) you have half as many needles, which will affect the finished size of the garment you can make. Mid-gauge machines have 150 needles and will knit sport, DK, worsted, and Aran weights. Most bulky yarns will have to knit on every other needle. Chunky-gauge machines have 110 needles and knit worsted and Aran weights with the bulkies on every other needle. These are just guidelines and very often you can stretch the range of yarns that a machine will knit by knitting slowly, using extra weights, and bringing needles out to holding position so the carriage can knit them back more easily. People develop lots of little tricks, but remember that the ideal range for any machine is the middle of the stitch-size dial. Working at either extreme of stitch size will require a little something extra from you and is not the best place to try fancy textures and techniques.

Once you decide which machine to use, make sure you'll have enough needles. I just finished a Dale of Norway ski sweater for my son and had to knit the side borders separately to make the largest size. The pattern featured a main panel design with smaller designs at each underarm, so it was a perfect pattern for hiding extra seams. You can also use this method to simplify sweaters that have several very complicated patterns working at once—simply divide the body into four or six panels instead of just a front and back. If your seaming is good, nobody will know and the thread police won't arrest you for taking liberties with the original design.

You'll find that stitch gauge is generally easier to match than row gauge. Handknitters tolerate a bit of variation in row gauge because they measure the work in progress—you cannot do this on a machine

because the work is stretched and distorted. You need to convert all the length measurements to row counts by multiplying your row gauge by the desired length of each garment piece or section. Be careful to note whether the armhole starts at a given measurement above the *ribbing* or that same distance from the *beginning of the piece*. If your row gauge is very different from the row gauge given in the pattern, you may need to redistribute increases or decreases to duplicate the curves and shaping in the design. Make sure that the neckline shaping starts at the appropriate distance from the shoulder.

Most machine knitters work from a schematic rather than row-by-row directions. I usually draw a large schematic and write all my notes and directions in the appropriate places. Even if the pattern includes a schematic, it may be incomplete. You should write in the number of stitches for each section and convert all lengths to row counts. If there is no schematic with your pattern, draw one as you read through it. Every time you find a stitch count or a length, write it onto the blank schematic. You should be able to come up with all the necessary information to knit the garment.

Many handknit construction details need to be reworded for machine knitters. For example, handknit patterns generally deal with both sides of a neckline at the same time. As you read through the directions for a pullover front you'll find some variation of "knit so many stitches, join a second ball of yarn, bind off the center neck stitches and continue both sides at the same time." But machine knitters usually put the second shoulder into holding position while they shape the first side. So, if a pattern tells you to knit thirty-eight stitches then add the second ball, etc., you should leave the first thirty-eight stitches on the carriage side in working position and hold the remaining stitches while you shape the first shoulder.

Patterns written for circular handknitting (such as Lopi, Dale of Norway, and most traditional Fair Isle designs) are knitted flat by machine and seamed when done. To treat the front and back separately, you'll need to halve the body stitches and eliminate any extra stitches allowed for steeks. When you read through circular directions, remember that the directions are usually given for rounds and that stockinette is knitted every round, just as

the machine knits every row. If the directions specify a purl round, you need to use a garter bar to turn the work over after each of the next two rows because it takes two turns to produce a single garter ridge.

Most ribs and other garment details can be duplicated exactly. Many handknit patterns begin ribs with fewer stitches and then increase evenly in the first row of the body. For patterns that call for many increases in the first row, I sometimes cast on with scrap yarn, skip the rib, and begin the body. I then rehang the lower edge to knit the ribs because it is easier to reduce than increase stitches. Corrugated ribs are very fashionable again and I find that a one-by-one tuck stitch comes closest in looks and elasticity to the handknit version. Knitting two rows per color, tuck every other needle for two rows and then the alternate needles for two rows.

I make extensive use of scrap knitting for beginning and ending garment pieces (rather than binding off or using stitch holders). Use a fuzz-free yarn about the same size as your garment yarn and knit

about ten extra rows before dropping the knitting from the machine. If you scrap off shoulder stitches, you can use the machine-knit equivalent of a three-needle bind-off to join shoulder seams right on the machine. Just fold back the scrap and with the right side facing you, rehang the back shoulder stitches on the machine. Bring the needles all the way forward to holding position and push the stitches back against the bed. Rehang the corresponding set of front shoulder stitches in the hooks of the same needles. Then push the needle butts back to regular working position so that the front stitches are pulled through the back stitches. Bind off and you'll have a perfect shoulder seam with very little bulk. Also scrap off garment stitches when you want to place a knitted-in pocket—you can pick up the live stitches later to knit the rib band. Scrapped-off neckline stitches make a smoother transition to a neckband than bound-off stitches do; begin on scrap to retain live stitches at the lower edges for finishing later.

In short, I prefer live stitches to bound-

off most of the time because I still have the option of binding off later, but can leave the door open for other possibilities. And I always, always begin on scrap if my garment yarn is fragile or highly-textured. The scrap establishes the stitches on the bed and allows me to hang my weights before I begin.

Brother and Studio both publish basic reference books that describe garment details by machine. These books are available from your knitting-machine dealer and I recommend them highly. With a good reference to guide you, you'll find it gets easier and easier to do handknits by machine and I think you'll agree with me: stitches are stitches and rows are rows whether you knit them on two needles or a hundred! ∞

Susan Guagliumi is the education director for Studio By White Knitting Machines as well as a co-owner of the hand- and machine-knitting shop, Have You Any Wool? in Cheshire, Connecticut. Her book Hand Manipulated Stitches for Machine Knitters is published by Taunton Press.

Learn from Videos

Aren't near a store or knitting instructor?
Don't have time for a multi-week class?



Then learn from a video at your leisure.
Re-play when you missed something,
turn it on when you have time,
ask a friend over and learn together.



Free Catalog
Call
1-800-848-0284

Cardigan Details

by Meg Swansen. \$29.95

Knitting: Multi-Color Techniques

by Susie Hodges. \$39.95

Knit-Weave Technique

by Linda McGurn. \$29.95

Sock Video

by Nancy Wiseman. \$19.95

Knitting Glossary

by Zimmermann & Swansen. \$66.95



Yarn Barn/Victorian Video
930 Massachusetts
Lawrence, KS 66044

KRÜH KNITS

Featuring the KnitKing
Compuknit 5 Star Knitter

Merchants to the Machine Knitter®
ALL NEW CATALOGUE FOR 1998!

Over 13,500 items for machine knitters
**To receive our new 1998 Buyer's Guide
Catalogue, send just \$5.00 to**

**KRÜH KNITS • PO BOX 1587-1K • AVON, CT
06001-1587 1-800-248-KNIT**

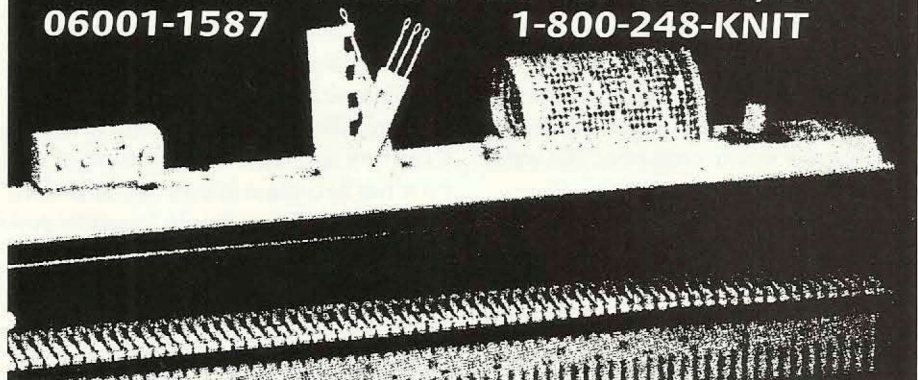

FOLKLORE

Robin Hansen



Luxury Luxus Deluxe

LUXURY. The lap of luxury. The expression conjures up images, doesn't it? For me "lap of luxury" evokes the image, probably from an N. C. Wyeth illustration, of Sinbad the Sailor in a jeweled turban lolling (another luxurious word) on silk cushions and attended by veiled, bejeweled, and scantily-clad women. Another image is of a beautiful woman—me in another incarnation—lounging in a deep, foamy bath, with large iridescent bubbles floating in the air around her pinned-up, long, wavy blond hair. That's luxury.

Then there are luscious luxury fibers, whose names resound with the exotic. Silk: the Mongol emperors of China, trays of mulberry caterpillars chewing noisily and tended by Japanese women who know them by name. Qiviut: Inuit women picking up from the tundra bits of fluff shed from hulking shy creatures like shaggy water buffalo. Cashmere: wealthy young Ivy Leaguers in subtly-colored sweaters so finely knit that the stitches are invisible. Fine linen: Grandmother's double-damask tablecloths, fingertip towels with hand-embroidered monograms worked by a schoolgirl about to enter marriage, bedsheets that weigh heavy but lie cool on the skin.

Luxury fibers feel good and have precious qualities like warmth or coolness, water resistance or absorbency. Those features make them pricey, as do scarcity and the fact they are often labor-intensive to produce. Their high cost can make them social and political issues.

Around the time of Christ, silk was carried from Han China across Asia to wealthy Romans, who paid for it in Roman iron coin, known for its poor exchange value. Traders began to insist on payment in gold and created such a drain on Roman gold that the senate proscribed the wearing of silk.

"Linen is always cool to the touch," textile expert Adrienne Hood of the Royal Ontario Museum once told me. Try touching linen and you'll find it's true, which is why linen is a desirable fiber for summer

clothing and bed linens. Linen is expensive and scarce because of its labor-intensive production; the fiber is soaked, beaten, and combed from the stems of flax plants. Because linen doesn't respond well to permanent-press chemicals and always needs ironing, the labor intensity is also high for the consumer. Fortunately, knitted linen doesn't need ironing.

Thirty years ago, cotton was fighting a life-and-death battle with acrylic, polyester, nylon, and dacron, and cotton was losing. But try working out in a nylon parka and you'll know why cotton recovered. This fiber doesn't retain heat and perspiration the way synthetics do. It breathes, we say, and we wear it to be cool in summer, and next to our skin in winter as protection from our woolly outer clothes. Now cotton is highly desirable, a new luxury fiber, carefully grown in natural soft colors.

In Japan's cold Aomori prefecture 100 years ago, only the nobility were permitted to wear silk or cotton cloth, the latter mostly imported from British India. Farmers and other working-class people wore hemp. Thin hemp fabric was layered and quilted together, then heavily decorated with cotton counted-darning-stitch embroidery (kogin) that improved its durability and warmth. Today, Americans are rediscovering hemp as a desirable, cool, clothing fiber. What the Japanese farmer a century ago regarded as a curse of the poor has become a luxury in the United States, where hemp can no longer be produced legally because of its connection with marijuana.

Then there are the luxury wools: think kid mohair, cashmere, Shetland lace, meri-

no. You can almost feel the light, soft touch of a Shetland shawl, the comfort of a cashmere sweater. As a knitter, you know that, for store-bought products, handknitting increases the labor of such garments, often making them expensive beyond affordability (unless you do the knitting yourself!).

Færoe Islands sheep walk around in hairy coats which they shed around mid-summer. Yarn for the finest sweaters is made of the lanolin-rich undercoat that remains after the hair has been pulled, lock by lock, from the fleece. Pulling hair from fleece is tedious work, and the resulting pure down yarn is virtually priceless. Like qiviut a few years ago, it's not for sale; instead it's delivered from the mill to Færoe Home Industries' shop to be knitted into sweaters, which *are* for sale.

Beaver hats, once worn by men of fashion and money, were not made of beaver skins, but of the felted underwool—again the down—of the beaver. Ojibwa trappers exhausted the eastern beavers and pressed beyond the Great Lakes for beaver pelts to trade. In Europe, beaver trappers so depleted the beaver that, for 200 years, the animals never built dams or lodges, which people came to believe were built only by American beavers. When beaver hats finally went out of style, the European beaver population surged and returned to normal beaver activities, astounding naturalists on that side of the Atlantic.

When I was very little, my mother told me about the ultimate luxury fiber. Not strictly speaking a fiber but a feather from the Hawaiian ohia, it decorated the cape worn by kings in old Hawaii. Each year the ohia grows two (yes 2) little bitty, lovely, red-orange feathers under its wings. A whole twittering of birds had to be caught and recaptured before the captors had enough feathers for a cape. That's labor intensive. That's luxury. ∞

Robin Hansen is a folklorist and freelance writer and knitter with a passionate interest in traditional knitting.

Nancie Knits Videos

by Nancie M. Wiseman

Newest
Video

LEARN TO KNIT, Basic Knitting and Sweater Finishing

Knit a small cardigan and learn all the basics of knitting and finishing techniques.

2 hours and 45 min. **\$49.95**

Three Techniques for More Colorful Knitting

Slip stitch, Intarsia and Fair Isle. **\$35.**

Continental Knitting

All the information needed to learn this faster knitting technique, with lots of closeups.

\$25.

Basic Sock Video

Information and pattern for creating simple socks.

\$20.

Add \$4.00 shipping and handling for each video.

Call or Write:

Nancie Knits

3214 Riverside Blvd. Sacramento, CA 95818

email: NancieKnits@prodigy.com

(916) 443-6238

ORDER LINE: 800 867-2074

Visa or MC

California residents add 7.75% tax.

The World's Largest Selection of Knitting Supplies

Where to Get the Yarn

THE BUTTONS, THE BOOKS & THE TOOLS

Yarn Packs for this issue

- *Andean Artistry*
- *Cradle to Couch*
- *A Natural Flair*
- *Opposites Attract*
- *Sideways Seed Jacket*
- *Cashmere Shawl*
- *Icelandic Lace Shawl*

Your source for all books
reviewed in this issue



Let us put
Yarn Paradise
in your mailbox!

Ask for our
84 page full
color catalog
and newsletter
subscription.

Visit us in person at our Yarn
Warehouse or on the web at
<http://www.patternworks.com>

Introducing The Sweater Wizard

Create a sweater
pattern in a minute with the
latest software for knitters.

Circular and flat styles with desired ease. Customize
sweater diagram on screen. *Windows 3.1/3.11 or 95/NT.*

D-106 The Sweater Wizard \$89.95



Stitch & Motif Maker

The first paint program especially
for knitters! Creates a grid up to 40
sts by 60 rows. 74-color and user-
friendly symbol palettes. *Windows 3.1/3.11 or 95/NT.*

D-107 Stitch & Motif maker \$89.95

D-106/67 Both Programs \$159

patternworks

Where your satisfaction is absolutely guaranteed

Orderline: 1-800-438-5464

PO Box 1690, Dept. IKF98, Poughkeepsie, NY 12601

HAVE YOU TRIED OUR Euroflax LINEN

OR  MERINO WOOL YARNS YET?

Louët

Custom spun to our exacting
specifications, using the finest
natural fibers available.

Available coast to coast at over
1000 Louët dealers.

Louët Sales, Inc.

P.O. Box 267-KN

Ogdensburg NY 13669

613-925-4502

Dealer inquiries welcome





BATTER-UP JACKET

BRIDGET ROREM

Tightly knit

Baseball jacket shaping

FINISHED SIZE 42¹/₂ (46¹/₂, 50³/₄, 55, 59¹/₂)" (108 [118, 129, 139.5, 151] cm) chest circumference, buttoned. Jacket shown measures 46¹/₂" (118 cm).

YARN Creskeld Guernsey 5-ply (100% wool; 246 yd [225m]/100 g): hyacinth, 11 (12, 13, 15, 16) balls.

NEEDLES Size 1 (2.25 mm): 40" (80 cm) circular (cir) for body; 16" (40 cm) cir and double-pointed needles (dpn) for sleeves. Adjust needle size if necessary to obtain the correct gauge.

NOTIONS Markers (m); smooth cotton waste yarn for holding gusset and neck sts; one size 3 (3.25 mm) needle for binding off; seven ³/₄" (2 cm) and two ¹/₂" (1.3 cm) buttons. Note: Longer jackets may require eight ³/₄" (2 cm) buttons.

GAUGE 34 sts and 44 rows = 4" in pattern st; 28 sts and 38 rows = 4" in reverse St st; 44 sts and 44 rows = 4" in twisted ribbing (unstretched).

THIS JACKET is very tightly knit with a guernsey-spun yarn that produces a dense and long-wearing fabric suitable for a working jacket. It is sized like a traditional man's baseball jacket, with wide blousy sleeves and a tight lower ribbing.

The body is worked as a single piece, from the bottom up, in an all-over diamond pattern that is not interrupted by side seams. I call the pattern "The Wind-Up". It features a reverse stockinette-stitch pitcher's mound that shows off a stockinette cable that resembles a pitcher "wound-up" to deliver. (Southpaws may wish to reverse the cables.) A row of small cables, representing teammates, sits atop each shoulder extension.

The sleeves are worked in reverse stockinette stitch to approximate the "woolly" look of some early baseball jackets and gussets give them roomy comfort.

All the edgings are worked in an elastic twisted ribbing. If you prefer less draw-in, work more stitches in the ribbing (up to the number of stitches in the body).

Note: Make adjustments to the body length at the beg of the body chart. To maintain pattern continuity, make adjustments in 18-row increments.

Stitches

Twisted Ribbing: (worked on an odd number of sts)

Row 1: *K1 tbl, p1 tbl; rep from *, end k1 tbl.

Row 2: *P1 tbl, k1 tbl; rep from *, end p1 tbl.

Rep Rows 1 and 2 for pattern.

Reverse Stockinette Stitch: (rev St st)

Row 1: (RS) Purl.

Row 2: Knit.

Rep Rows 1 and 2 for pattern.

•**Body:** With longer cir needle and using the cable method (see Glossary, page 6), CO 313 (345, 379, 411, 445) sts. Knit the first and last st of every row for selvedge sts and work rem 311 (343, 377, 409, 443) sts in Twisted Ribbing for 27 rows, or to desired length, ending with Row 1. Purl next row, inc 35 (39, 41, 45, 47) sts evenly spaced—348 (384, 420, 456, 492) sts. Work the Body chart as follows: Work 1 edge st, beg with Row 1 (19, 1, 19, 1) and beg as indicated for your size, follow chart from right to left to the center back st, then follow chart from left to right, ending with 1 edge

st. Cont in this manner until piece measures about 14 (15³/₄, 17¹/₂, 19, 20¹/₂)" (35.5 [40, 44.5, 48.5, 52] cm) from beg, or desired length to gusset, ending with Row 54 of chart. Work 83 (92, 101, 110, 119) sts, pm, p2, pm, work 178 (196, 214, 232, 250) sts pm, p2, pm, work to end. Slip ms each row.

Gussets: The oddly-shaped gussets "cheat" by obtaining slightly more than half of their sts from the diamond which forms between the purl sts as they move diagonally. This causes the sleeve to look more set-in than gansey style. The gussets are worked in rev St st centered over each of the two side "seam" stitches. Cont body sts in pattern and *at the same time*, work the gusset sts as charted, working gusset M1 incs on RS rows as follows: Work to 1 st before m, with left needle, lift the horizontal bar between the needles and purl into the back of it, p2 gusset sts, with left needle, lift horizontal bar between the needles and purl into the front of it. Note that the st before the first gusset inc and the st after the last gusset inc are also added to the gusset (the gusset incs by 4 sts) on each inc row. On the last gusset inc row, place 26 gusset sts on smooth waste yarn to be worked later with sleeve sts.

Upper body: The fronts and back are worked simultaneously with separate balls of yarn as follows: With WS facing, work across 77 (86, 95, 104, 113) left front sts, inc 1 st for selvedge at armhole edge; join new ball of yarn, inc 1 st, work across 166 (184, 202, 220, 238) back sts, inc 1 st; join another ball of yarn, inc 1 st, and work rem 77 (86, 95, 104, 113) right front sts—324 (360, 396, 432, 468) sts total; the 4 inc'd sts are selvedge sts and are to be knit on every row. Cont in patt until 6¹/₂ (7, 7¹/₂, 8, 8¹/₂) diamonds have been completed above ribbing, ending with Row 53 of chart; piece should measure about 23³/₄ (25¹/₂, 27, 28³/₄, 30¹/₄)" (60.5 [65, 68.5, 73, 77] cm) from beg. **Shape left front neck:** Work 19 (22, 25, 28, 31) right front sts and place on holder, work rem 59 (65, 71, 77, 83) right front sts, work across back sts, work left front sts, placing last 19 (22, 25, 28, 31) sts worked on holder. Do not cut yarn; it will be used later for button band. Join new yarn at left front neck edge and cont in patt, dec 1 st at each neck edge every row 5 times—54 (60, 66, 72, 78) sts rem. Cont in patt for a total of 20 (22, 24, 26, 28) rows from last dec row, end with Row 54 of chart. Work next row as follows: K2, *p2, k4; rep from *, end last rep k2. Do not BO. **Shape right**



Creskeld Guernsey
5-ply; 14 wraps per inch

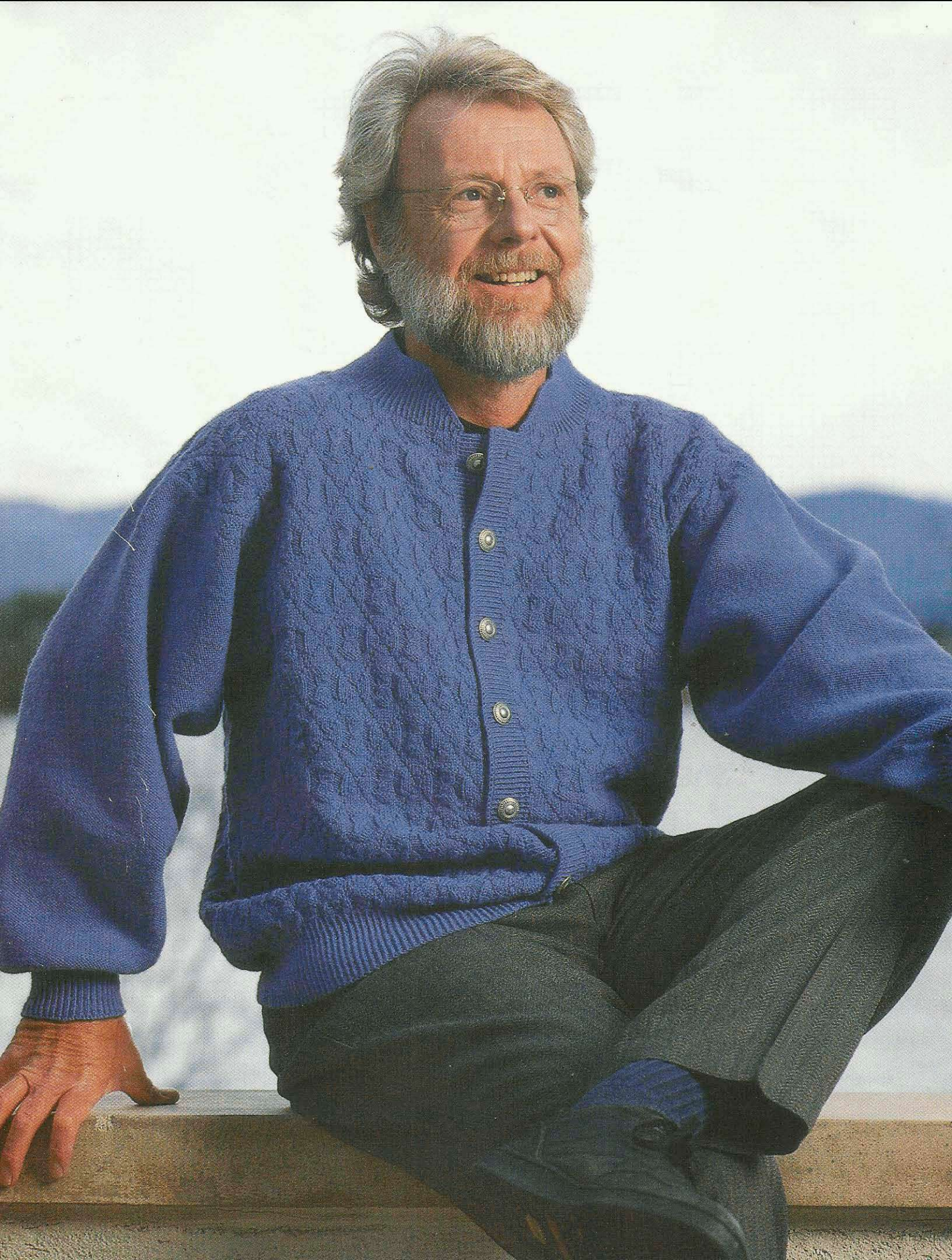

Body

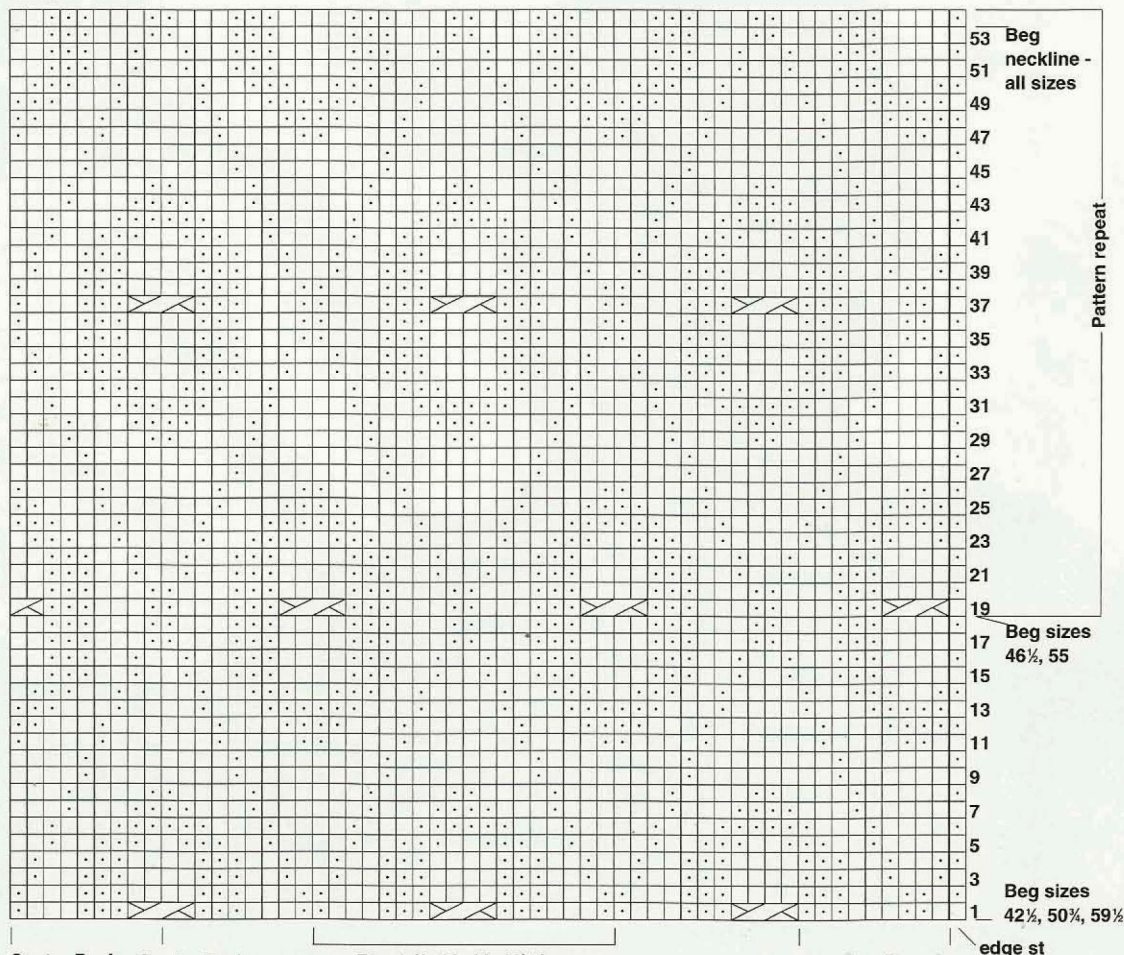

Shoulder Extension

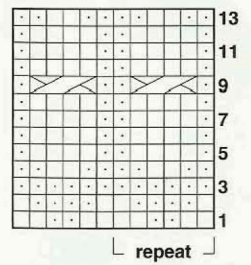

- M Make 1
- k k on RS; p on WS
- p p on RS; k on WS
- / k2 tog
- \ ssk
- / \ 2/2RC: sl 2 sts onto cn and hold in back, k2, k2 from cn

Center Back sizes 46½, 55 Center Back sizes 42½, 50¾, 59¾ Rep 8 (9, 10, 11, 12) times Beg sizes 46½, 55 Beg sizes 42½, 50¾, 59¾

Work edge st, beg as indicated, work to center back, then work chart in reverse order, ending with edge st.

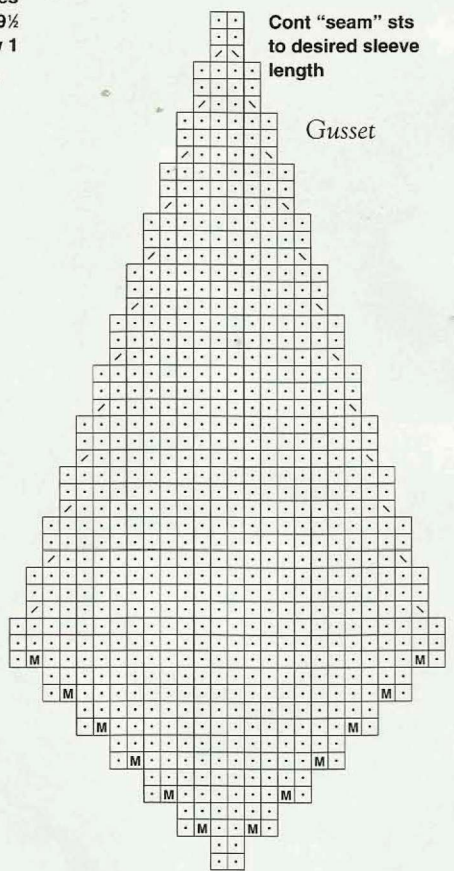
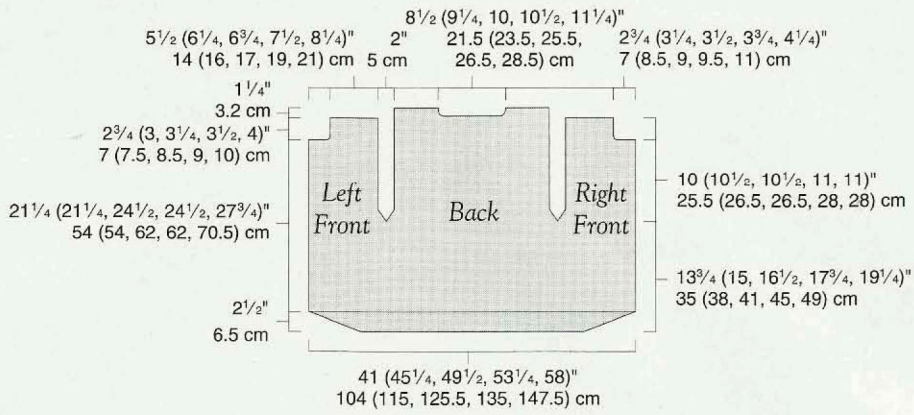
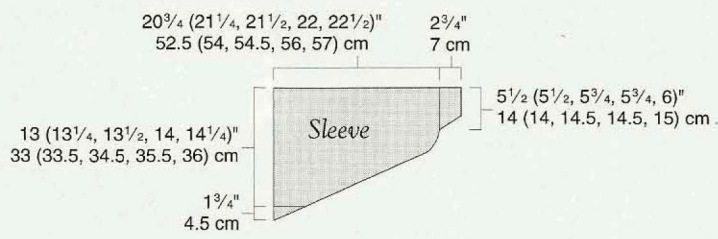

front neck: Place 59 (65, 71, 77, 83) right front sts on needle, leaving 19 (22, 25, 28, 31) sts on holder for front band. Work as for left front neck, reversing shaping. **Upper back:** Cont in pattern on 168 (186, 204, 222, 240) back sts until back measures same as fronts. **Shoulder extensions:** Work 54 (60, 66, 72, 78) sts each side according to Extension chart, dec 1 st each neck edge every row 5 times. Use Kitchener st (see Glossary, page 6) to graft the shoulders sts tog, keeping back sts in purl and front sts (as much as possible) in Row 2 of Extension chart. Leave rem 72 (75, 78, 81, 84) sts on needle for back neck.

•**Sleeves:** With shorter cir needle RS facing, purl across 26 held gusset sts, pick up and knit 91 (93, 95, 97, 99) sts up armhole to shoulder, 91 (93, 95, 97, 99) sts down to top of gusset—208 (212, 216, 220, 224) sts total. Place m and join. Follow Gusset chart, dec 1 st each side of gussets every 3 rnds until 2 gusset (“seam”) sts rem. Then dec 1 st each side of “seam” sts every 4 rnds 38 (39, 40, 41, 42) times, changing to dpn when necessary—108 (110, 112, 114, 116) sts rem. **Dec rnd:** Purl, dec 25 sts evenly spaced. Purl 3 rnds. **Dec md:** Purl, dec 7 sts evenly spaced—76 (78, 80, 82, 84) sts rem. (Note: for a wider cuff, dec 24 sts on the first dec rnd and omit the second dec rnd—84 [86, 88, 90, 92] sts rem.) **Cuff:** Work

Twisted Ribbing for 31 rnds, or to desired length, ending with Row 1 of patt. With larger needle, BO all sts in Twisted Ribbing.

•**Finishing: Front Bands:** Determine which band will have buttonholes; men’s buttonholes are customarily on the left front, women’s are on the right. **Left front band:** With RS facing and using yarn end from neck edge row, pick up and knit 1 st for every row (including ribbing and CO row), working bet the selvedge st and first pattern st—145 (153, 163, 171, 181) sts. Knit the first and last st of every row and work rem sts in Twisted Ribbing, beg with p1 tbl. Cont in ribbing (knitting first and last st of every row). If this is the buttonhole band, on 8th ribbing row (RS) space seven 7-st one-row buttonholes (see Glossary, page 7) on body portion of band and two 5-st buttonholes on ribbing portion of band. (Longer jackets may require eight buttonholes on the body portion.) Work 15 rows in ribbing. **Next row:** (RS) K1, *k2tog; rep from * to last 2 sts, k2. With larger needle, BO all sts in knit. **Right front band:** With RS facing, pick up and knit sts as for left front band. Work as for left front band (omitting buttonholes if they were worked on the left front), working 16 ribbing rows rather than 15. **Next row:** (WS): P1, *p2tog; rep from * to last 2 sts, p2. With larger needle, BO all sts in purl. **Collar:** With RS of right front facing, knit 19 (22, 25, 28,

31) held right front sts, inc 3 (4, 5, 6, 6) sts as you go; pick up and knit 9 sts along curved portion of right front neck, 25 (27, 29, 31, 33) sts along right side neck, and 9 sts along curved portion of right back neck; knit 60 (66, 72, 78, 84) held back sts, inc 11 (13, 15, 17, 19) sts as you go; pick up and knit 9 sts along curved portion of left back neck, 25 (27, 29, 31, 33) sts along left side neck, and 9 sts along curved portion of left front neck, and then knit 19 (22, 25, 28, 31) held left front sts, inc 3 (4, 5, 6, 6) sts as you go—201 (221, 241, 261, 279) sts.

Row 1: (WS) Work Twisted Ribbing, beg and end with p1 tbl. Place m at center st when you come to it.

Row 2: Sl 1 kwise, sl 1 pwise, pm; work rem sts as established.

Row 3: Sl 2 pwise, work rem sts as established to m; turn.

Cont in this manner, working 2 fewer sts each row until 17 rows have been completed.

Row 18: Sl 1 kwise, sl 1 pwise, work to closest m in Twisted Ribbing, k18.

Row 19: Sl 1 pwise, p17, p2tog to center m, p1, p2tog to next m, p18.

With smaller needle, BO in purl. Weave in loose ends. Sew buttons to button band, placing both smaller buttons in the lower ribbing.

Bridget Rorem designs and knits in Essex, Illinois. She has been known to clean her house.

You can personalize the jacket to reflect your own interests or passions; a gardener or golfer (or someone who works in the criminal justice system) might have an eye out for “Snake in the Grass”. “Happy Feet” can serve walkers, runners, and joggers. A ballroom dancer could arrange left and right feet to approximate a favorite step. Try working initials or a favorite embossed stitch within the diamond pattern.

b k1 tbl on RS
p1 tbl on WS

b p1 tbl on RS

1/1RCBP: RS and WS: sl 1 st onto cn and hold in back, k1, p1 from cn

1/1LCBP: RS and WS: sl 1 st onto cn and hold in front, p1, k1 from cn

WS: sl 1 st onto cn and hold in back, k1, k1 from cn

WS: sl 1 st onto cn and hold in front, k1, k1 from cn

Happy Feet; Left Foot

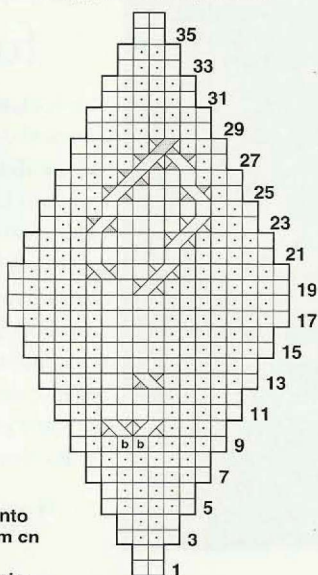

Happy Feet; Right Foot

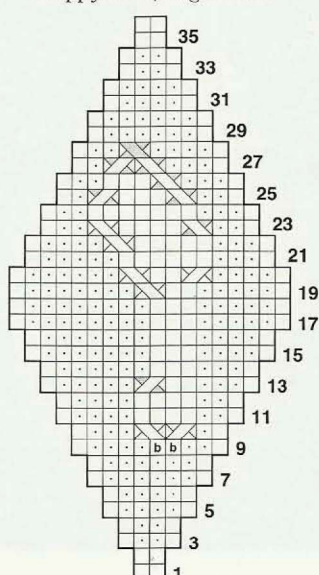

Snake in the Grass

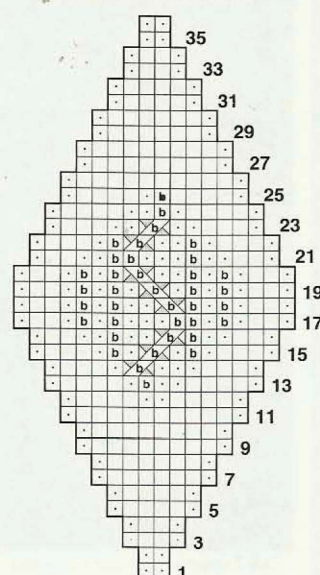

1/1RC: RS: sl 1 st onto cn and hold in back, k1, k1 from cn; WS: sl 1 st onto cn and hold in back, p1, p1 from cn

1/1LC: RS: sl 1 st onto cn and hold in front, k1, k1 from cn; WS: sl 1 st onto cn and hold in front, p1, p1 from cn

b RS: sl 1 st onto cn and hold in back, k1 tbl, p1 from cn; WS: sl 1 st onto cn and hold in back, k1, p1 tbl from cn

b RS: sl 1 st onto cn and hold in front, p1, k1 tbl from cn; WS: sl 1 st onto cn and hold in front, p1 tbl, k1 from cn

knit-ol-o-gy:

The science of making knitting affordable and enjoyable for everyone.

It's what we do!

Yarns & Patterns
Books & Videos
Needles & Tools
Much, much more

80 page color catalog
only \$3



Woodland Woolworks

PO Box 400
Yamhill, OR 97148
Voice/fax: 503-662-3641
woolwrks@teleport.com

Orders: 800-547-3725



DESIGN-A-PATTERN '98 CHARTING PROGRAMS FOR WINDOWS

- ✓ The most VERSATILE & EASY-TO-USE programs to chart ACCURATE patterns for any sizing (infants to mature adults)
- ✓ The only charting programs with Unlimited FREE Upgrades and Unlimited 'Lives' for your back-up protection
- ✓ Chart custom patterns for punchcard and electronic machines without expensive computer interface cables or upgrades
- ✓ Multiple text & graphic printout options, row-stitch design grid generator and many other customer-suggested features
- ✓ Still only \$75 each with increasing discounts for extra volumes

Latest Design-A-Pattern Features Include:

- ☛ Custom design & sizing with 50+ templates in four volumes
- ☛ New Measurement Overlay option added for panel graphics

Call Ileen for free demo disks and information on knitting equipment and programs

ILEEN'S NEEDLE NOOK

4106 West Ely Road
Hannibal, MO 63401

PHONE: 1-800-221-NOOK • E-MAIL: ileen@nemonet.com
FAX: 1-573-221-4107



When you get right down to it, it's the color and... *color is our business.*



Nell Znamierowski, Color Consultant

Beautiful Yarns for Knitting

Our Color Consultant, *Nell Znamierowski*, begins with a rich color palette for our dyed fleece and then blends these solid colors together to create vibrant accents and subtle heathers. Our line is distinctive and complimentary ...from spring pastels to rich jewel tones and they work so well together because they were all created from the same palette. Ask for *Harrisville Yarns* - they are *never skein dyed!*

*Distinctive Tweeds
and
Soft Heather Yarns*

Spun at our mill in New Hampshire!



HARRISVILLE DESIGNS

Center Village, Box 806, Harrisville, New Hampshire 03450

Yarn Catalog: \$6.00

1-800-338-9415

IN THE ROUND

Nicky Epstein



An Evening with a Close-Knit Group

WHILE ON A recent book-signing weekend in Washington D.C., I had the opportunity to visit with an all-male knitting group. It's not that "men who knit" are such an unusual phenomenon, but knitting today is an activity most associated with women.

History tells us that early knitters were men, that production knitting was controlled by all-male professional guilds, and that in some ancient cultures it was actually illegal for women to knit. Knitting didn't become women's domain until late in the eighteenth century. Nowadays, bands of hearty men throughout America still practice the art. I met the Washington group at a lovely apartment. The group included a carpenter, a legal secretary, a construction worker, and an attorney. The ideas and views that we exchanged about knitting transcended sexual lines.

The group ranged from beginning to advanced knitters and some had been knitting for more than twenty years. All were taught the basic skills by their mothers when they were between the ages of nine and twelve. Tim's mother could only knit mittens, so at an early age he was knitting beautiful, intricate mittens. He is now teaching his mother to knit sweaters and enjoying the role reversal. All the men claim to be better knitters now than their mothers or sisters and often show them a technique or two.

A couple of the knitters averaged one to two projects a year while others did upwards of fifteen; though most concentrated on sweaters, some tried other projects as well.

We had a show and tell. To my delight, one man had used my basketweave floral hat design as the starting point for a great Christmas stocking. All the projects showed an amazing variety of style and technique. Beautiful silk/angora fingerless mittens, a cotton guernsey pullover, a Fair Isle vest, a five-foot cabled scarf, many colorful mittens, hats, and socks, and an

allover rib pullover. Like most knitters I know, the group took particular satisfaction in giving their knitted items to family and friends.

Again as with most knitting groups, taste in knitting styles varies greatly among the members, but they all have one thing in common—interest in developing new skills and trying inventive techniques. Joe's wife is a more advanced knitter than he is, but he took pride in correcting her purling technique. He says knitting is a great way to pick up girls, though he leaves that to single men. Witt once got a free flight coupon from a flight attendant for helping her learn to knit.

Though some have participated in co-ed groups, the men enjoy the all-male group. As Brian put it, "there's a different dynamic in participating in a group of one gender."

Men were the original knitters and more and more of them across the country are returning to the craft. I've always thought that knitting is a creative and recreational pursuit that transcends gender—and after this charming experience with this close-knit group, I'm convinced of it. ∞

Nicky Epstein has lived and worked in New York City for twenty years. She is author of The Knitted Hat Book published by Taunton Press and is currently at work on Decorative Knitting to be published by Interweave Press.

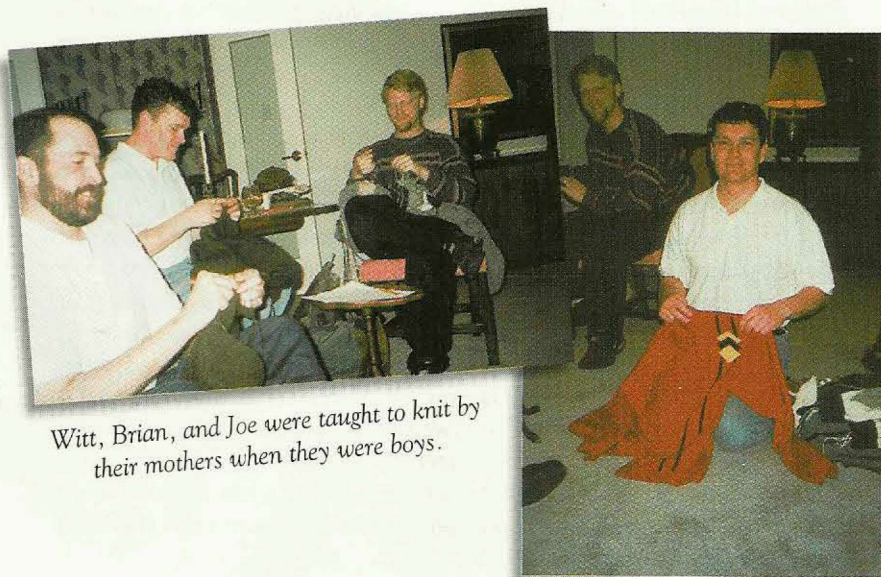

Witt, Brian, and Joe were taught to knit by their mothers when they were boys.

The items knitted by the group showed an amazing variety of style and technique.





CRADLE-TO-COUCH BLANKETS

EILEEN MEHL

Gansey patterning

Personalized with initials

FINISHED SIZE *Cradle blanket:* About 38" (96.5 cm) wide by 46" (117 cm) long. *Couch blanket:* About 48" (122 cm) wide by 51" (129.5 cm) long.

YARN *Cradle Blanket:* Unique Kolours Shepherd Bambino 6-ply (100% superwash wool; 87 yd [80 m]/25 g; #51 optical white, 22 balls. *Couch Blanket:* Tahki Austermann Revue (100% Merino wool; 109 yd [100 m]/50 g; #63 pearl gray, 19 balls.

NEEDLES *Cradle blanket*—Size 5 (3.75m): 32" (80 cm) circular. *Couch blanket*—Size 7 (4.5 mm): 32" (80 cm) cir. Adjust needle size if necessary to obtain the correct gauge.

NOTIONS Markers (m); cable needle (cn); tapestry needle.

GAUGE *Cradle blanket:* 26 sts and 33 rows = 4" (10 cm) in St st. *Couch blanket:* 20 sts and 26 rows = 4" (10 cm) in St st.



Unique Kolours Shepherd Bambino
6-ply; 2-ply; 13 wraps per inch

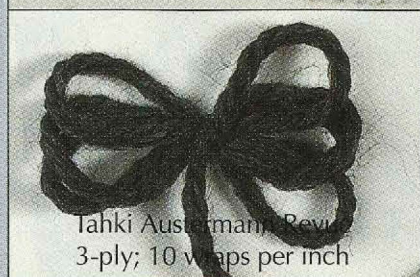

Tahki Austermann Revue
3-ply; 10 wraps per inch

WHEN WE LOOK at and touch handmade objects bearing names, initials, or dates associated with our forebears, we have a link with the past. Most often, women have created these treasures to honor a person or place in time. In doing so, they have created a sense of belonging to a family, a community, a history, or a people.

This creation of continuity is one of the reasons I enjoy making personalized gansey blankets as gifts. I enjoy designing them for others to knit for the same reason, and also because it is a good way for knitters to get acquainted with textured knitting. This project requires no shaping, no sewing, and no specific sizing. It is comprised of knit and purl stitches with a few cables.

These two blankets follow the same pattern. One is worked with fingering weight yarn, the other with worsted-weight. Changing yarn and needle sizes changes the overall dimensions. The yarns are extremely soft, giving the blankets beautiful drape and making them wonderful to wrap up in. However, the softness does tend to make the blankets "grow" in length, and this should be considered when deciding how long to knit them. Once blocked, they are 10 to 15 percent longer and slightly narrower.

Note: Join new yarn in the seed stitch areas where the darned ends will be less noticeable. Remember to read charts from left to right on WS rows.

CO 246 sts. Work garter st (knit every row) for 7 rows. *Inc row:* (WS) K24, M1, [k4, M1, k20, M1] 2 times, k4, M1, k94, M1, k4, [M1, k20, M1, k4] 2 times, M1, k24—258 sts. *Note:* The first and last 4 sts form garter borders.

Row 1: K4, pm, k18, pm, work 62 sts according to Chart 1 (see page 63), pm, k12, pm, work 66 sts according to Chart 2 (see page 63), pm, k12, work 62 sts according to Chart 1, pm, k18, pm, k4.

Row 2: K4, p18, cont working Chart 1 across 62 sts, p12, cont working Chart 2 over 66 sts, p12, cont working Chart 1 across 62 sts, p18, k4.

Cont in this manner, working border sts in garter st, center panels as charted, and rem sts in St st until piece measures 47" (119.5 cm) or 1" (2.5 cm) less than total desired length, ending with a WS row and adding initials as desired

CORRECTING MISTAKES

THIS PATTERN is visually easy to follow. It uses diagonals, columns, and rows so a mistake can be easily seen and corrected in the following row. Keep a crochet hook handy for corrections.

It is also helpful to make a mental note of when each pattern repeat begins and on which side of the work. For instance, the diagonal lines flanking a cable always start on the wrong side, and the next row, which is on the right side, has the cable crossover.

When setting up the first row I find it helpful to put a marker in the middle of the increase stitches where the cables will be. With so many stitches this serves as a reference for the pattern stitches and you don't have to count all the stitches over and over again.

If you see a mistake somewhere down in your knitting, don't be afraid to drop down one column at a time to get to it and correct it. You don't want to rip out 258 stitches per row! When you reach the mistake, use your crochet hook and follow the graph vertically. For knit stitches, pull the yarn from the back to the front; for purl stitches, pull the yarn from the front to the back. If there is a mistake in the cable, drop down all 6 stitches at once and "reknit" the cable crossover using a small wooden cable needle and the ladder of yarn from the row immediately above. Then use your crochet hook to latch up the stitches by column in the rows above. Be sure to take your crochet hook out each time and reinsert it to avoid twisted stitches.



The Zimmermann Effect...

Elizabeth Zimmermann and her daughter Meg Swansen have promoted the knit-to-fit technique using any gauge. Their formulas for calculating patterns frees you from depending on a printed pattern.



BOOKS

<i>Knitting Around</i>	\$26.00
<i>Knitting Without Tears</i>	15.00
<i>Handknitting with Meg</i>	15.95
<i>Knitting Workshop</i>	17.95

VIDEOS

<i>Knitting Workshop</i>	6 hours	95.00
<i>Knitting Around</i>	6 hours	95.00
<i>Knitting Glossary</i>	4 hours	66.95
<i>Cardigan Details</i>	90 min.	29.95
<i>A Fair Isle Vest</i>	60 min.	29.95

Shipping cost will be added to order.



CALL 1-800-468-0035

YARN BARN
 930 Massachusetts
 Lawrence, KS 66044

We have several catalogs -- just request our **Knitting and Crochet Catalog** and our **Victorian Video Catalog**. Need needles or yarn? We have them, too.

Not Just for Special Occasions ...



Brittany
 fine wood knitting needles & crochet hooks

P.O. Box 130
 Dept. IK
 Elk, CA 95432

Phone Toll-Free
 1-888-488-9669

express circular needles dmc anchor pearl 12 inox needles pearl 8 cutwork linen brittany double points floss
 pearl 5 danish dmc an **THREADS & NEEDLES** needles medic
 pearl 3 metallic over hooks persian tape needles pearl 8 cutw FOR ALL NEEDLEWORK ver floss
 hooks wool c FROM THE BASICS TO THE BIZARRE flower thread afghan
 knitting yarns s WE HAVE AN AMAZINGLY ECLECTIC STOCK etalic overdye crochet
 pearl double point floss
 danish needles
 dmc anchor pearl 12 inox needles pearl 8 cutwork linen brittany doubles points pearl 5 silk cotton clover
 pearl 3 metallic overdye c CALL OR WRITE FOR OUR CATALOG ici danish flower thread afghan
 hooks persian tapestry marlitt needles dmc anchor pearl 12 inox
 needles pearl 8 cutwork linen **1-800-660-4355** lover pearl 3 metallic overdye floss
 crochet hooks wool cebelia opera read afghan hooks persian tapestry
 linen brittany double po THE NEEDLEPOINT JOINT chet hooks wool cebelia floss
 marlitt knitting yarns si ox needles pearl 8 cutwork
 opera tatting shuttles medicine danish flower thread afghan hooks persian tapestry marlitt knitting yarns silk
 ribbon expres **241 HISTORIC 25th STREET • OGDEN, UTAH 84401** brittany double points
 pearl 5 silk cotton clover pearl 3 metallic overdye crochet hooks, wool cebelia opera tatting shuttles, meici floss
 danish flower thread afghan hooks persian tapestry marlitt knitting yarn silk ribbon express circular needles

(see below). *Dec row:* (RS) Dec by working ssk, k2, k2tog at each cable as follows: K24, [ssk, k2, k2tog, k20] 2 times, ssk, k2, k2tog, k94, [ssk, k2, k2tog, k20] 2 times, ssk, k2, k2tog, k24—246 sts. Beg with a WS row, work garter st for 7 rows. BO all sts—4 garter ridges. Block.

Optional Initials: If you want the initials in the upper right corner, complete all of a gansey pattern except for the last 10" (25.5 cm) or so. Graph the initials and the exact placement in relation to

the 18 St sts. Using graph paper, block in your letters or numbers; purl these sts. Check the math against *your* row gauge to be sure you have the spacing as you want it. You may find it helpful to mark the side of the blanket where the initials will go so you don't mistakenly work them on the wrong side (left as opposed to right) of the blanket.

To put a name or initials in the center panel, drop out every other row of center stitches in the center repeat.

This allows for letters up to 11 sts wide. Very wide letters such as M or W may need to be adjusted to fit the space. Adding the date for a birth or wedding is a nice touch. ∞

Eileen Mehl lives in Columbus, Ohio, where she has been knitting for twenty years while raising five children. Her kids are delighted that she publishes her knitting designs; now when asked what their mother does, they can say something other than "She stays home and knits."

Chart 1

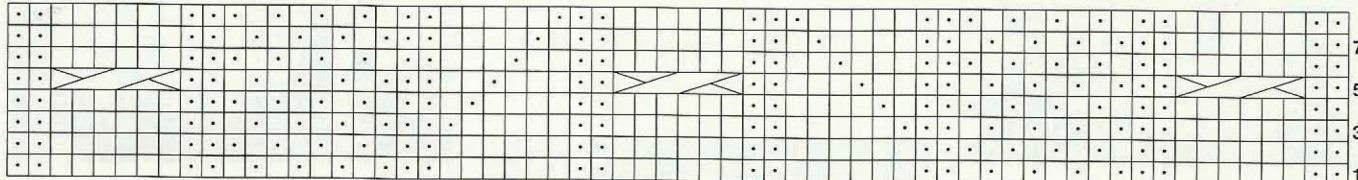
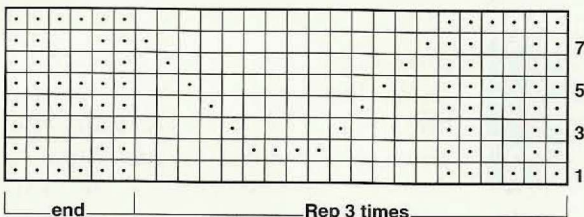

Chart 2



□ k on RS;
p on WS

• p on RS;
k on WS



3/3 RC: sl 3 sts onto cn and hold in back, k3, k3 from cn

275 and Counting!

That's how many Knitting Books we distribute—from the classics to the newest best-sellers.

Many yarn and specialty stores across the country stock our books. Check with your local store or send \$3.00 for a copy of our catalog to:

UNICORN
BOOKS AND CRAFTS, INC.

1338 Ross Street
Petaluma, California 94954-1117
Phone: 707-762-3362
Fax: 707-762-0335

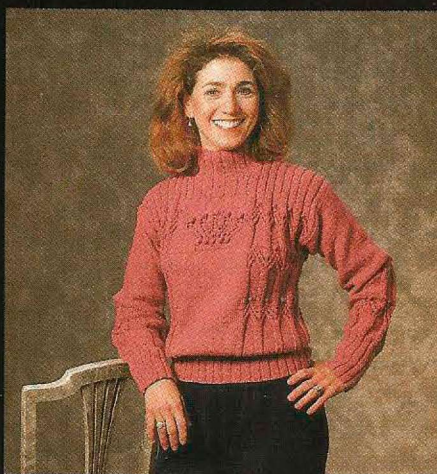

DANISH CROWN, Finished sizes 37-46, From \$104

SAMUEL CHARIS KNITS

FINE SWEATERS IN KITS

UNIQUE DESIGNS, LUXURIOUS YARNS

Catalogue: 3 issues \$10/year—refundable with purchase

1-800-321-KNIT • 916-392-8213 • fax 916-392-8216 • email: knitkits@knitkits.com

Visit our website at: www.knitkits.com

2443 Fair Oaks Blvd., Suite 241, Sacramento, CA 95825

CONNECTIONS

Judith Durant



Wool Festival at Taos



LaLana Wools of Taos offered a free indigo dip-in for festival attendees.

THIS IS TRULY A FEAST for fiber freaks. Once a year in Taos, New Mexico, breeders, spinners, dyers, knitters, weavers, and others gather to celebrate wool. (Or is that celebrate to gather wool?) Joe Coca, *Knits* photographer, and I attended the fourteenth annual Wool Festival September 27 and 28, 1997, and I can hardly wait for the fifteenth. Located at Kit Carson Park, just off the Taos Plaza, last fall's fairgrounds held sixty booths full of fiber and related paraphernalia—raw fleece and rovings from rare sheep, alpacas, llamas, and mohair goats; angora fiber and blended batts; combs, carders, and spinning wheels; yarn and loads of knitting, crochet, and weaving tools; dyestuffs; garments, wall hangings, and rugs; jewelry, notecards, and more.

In addition to these wonderful opportunities to spend money, the festival offers ongoing shows and demonstrations. Six times



Ongoing demonstrations are fun and educational. Here an angora breeder explains the characteristics of the fiber from her rabbits.

a day, Tom Barr from the San Luis Valley shears a sheep with astounding skill and speed. All day long, the Sheep Showcase features not only different and unusual sheep breeds but also includes alpacas and llamas, as well as Angora, Cashmere, and Pygora goats. The Handspun Yarn Show features yarns spun for competition in both adult and youth divisions; fibers must be



Spinning is child's play, or so it seemed while watching this adept youth ply her craft.

grown in the Colorado/New Mexico area, and the fine examples include wool, mohair, angora, llama, and alpaca yarns. The Fleece to Fabric Show presents entries in three-part displays: raw fleece, the same fleece in some state of processing, and finished goods woven, knitted, or crocheted from the fleece. The Fashion Show features garments made from U.S.-grown animal fibers that are judged in various categories including Most Unique Use of Fiber. And that's not all. There's kids' hands-on, and all kinds of demonstrations of spinning, carding, weaving, and knitting.

The fifteenth annual Wool Festival at Taos will be held September 26 and 27, 1998. We hope to see you there! ∞

Judith Durant is determined to finish knitting at least one sweater before she goes back to Taos where she will undoubtedly buy more wool.



Fiber in all forms, from raw fleece to knitted and woven items, is available for sale.

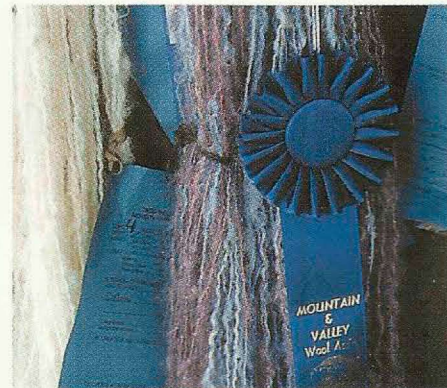

Contest results are splendid at the show.

LACE, LACE, AND MORE LACE!

From California to Manhattan to Russia—Interweave Press has searched the globe to provide lace knitters with previously unpublished patterns.

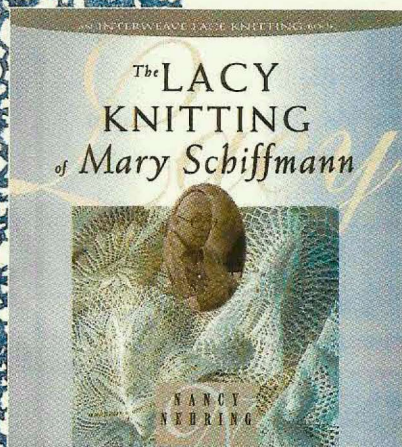

The Lacy Knitting of Mary Schiffmann
Nancy Nebring
Aunt Jennie's knitted lace, Aunt Lucy's lace, lace inspired by Mary's lifelong passion for astronomy—you'll find it all here, plus accounts of how she came to find and write directions for her patterns.

8½ × 9, paperbound, 96 pages, charts and duotone photos. #776—\$17.95 + s&h

Traditional Knitted Lace Shawls
Revised Edition
Martha Waterman

This completely revised edition of the classic text offers everything you need to know about knitting lace shawls and includes instructions for eight magnificent creations.

8½ × 9, paperbound, 112 pages, charts and duotone photos. #911—\$21.95 + s&h

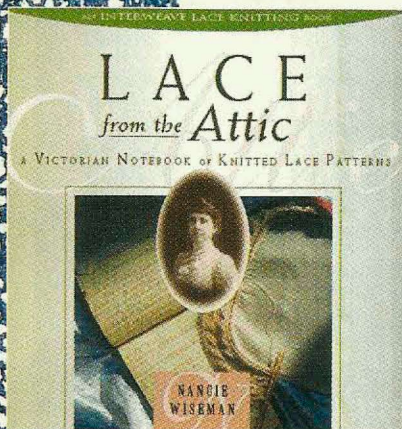
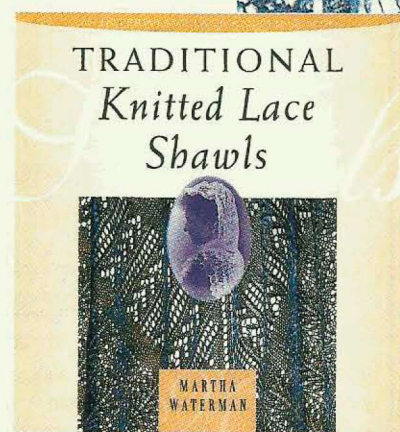

Lace from the Attic
A Victorian Notebook of Knitted Lace Patterns
Nancie Wiseman

Nancie Wiseman has lovingly recreated each pattern from Blanche Beau's attic and has updated all with easy-to-follow abbreviations and terminology. She also

offers ways to incorporate the patterns into projects.

8½ × 9, paperbound, 96 pages, charts and duotone photos. #775—\$17.95 + s&h

*Gossamer Webs**
The History and Techniques of Orenburg Lace Shawls
Galina Kbmeleva & Carol R. Noble

This is the only book available on Russian shawl knitting, and it provides all the technical background you need for knitting and blocking one of these heirloom shawls.

8½ × 9, paperbound, 144 pages, charts and duotone photos. #774—\$21.95 + s&h

*Available in November

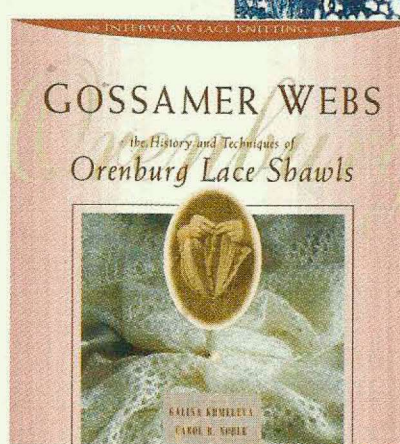

To order, call Dept. IWPK at **800-289-9276** or use the order form on page 4.
Interweave Books 1338 Ross Street Petaluma, CA 94954-6502
<http://www.interweave.com>

Free Interweave Catalog!
Call 800-289-9276!

EVERYTHING YOU NEED FOR YOUR NEEDLEWORK PROJECTS

(and maybe some things you didn't even know you needed!)

We stock over 1,000 different yarns
in a huge array of colors including:

- Vittadini
- Jaeger
- Classic Elite
- Tahki
- Colinette
- Prism
- Rowen
- Lang
- Lane Borgoesia
- Noro
- Plymouth
- Harrisville
- Annabelle Fox
- Dale of Norway
- Cynthia Helene
- Missoni
- Filatura
- Jo Sharp
- Berroco
- Brown Sheep
- Gedifra
- GGH
- Katia
- Maños
- Mountain Co.
- Muench
- Patons
- and lots more!

To Order: 1-800-306-7733

PERSONAL THREADS
BOUTIQUE

Knitting • Weaving • Spinning • Needlepoint

8025 West Dodge Road • Omaha, Nebraska 68114 • Fax: 402-391-0039
e-mail: carolyn@personalthreads.com • web: www.personalthreads.com

For a free newsletter/catalog send a card
with name, address, phone and your interests.

MICHIGAN FIBER FESTIVAL^{INC.}

THE
TRADITION
CONTINUES . . .

AUGUST 13 ~ 16, 1998

Allegan County Fairgrounds, Allegan, Michigan
Gate \$3⁰⁰ per person Parking is Free

Featured Teacher—Sylvia Graham

Sheep, Llamas, Rabbits, Angora Goats, Alpacas
Spinning, Weaving, Basket Making • Sheep Shearing,
Merchant Booths • Fleece Shows, Fiber Arts Show
Herding Demonstrations • Fleece-to-Shawl Contest

Free Demonstrations

For information/booklet, write:

142 East State Street, Hastings, MI 49058
(616) 945-2816 • Fax (616) 948-9825
E-mail: ladyp@mvcc.com

Exquisitely Angora
by Rosalie Truong

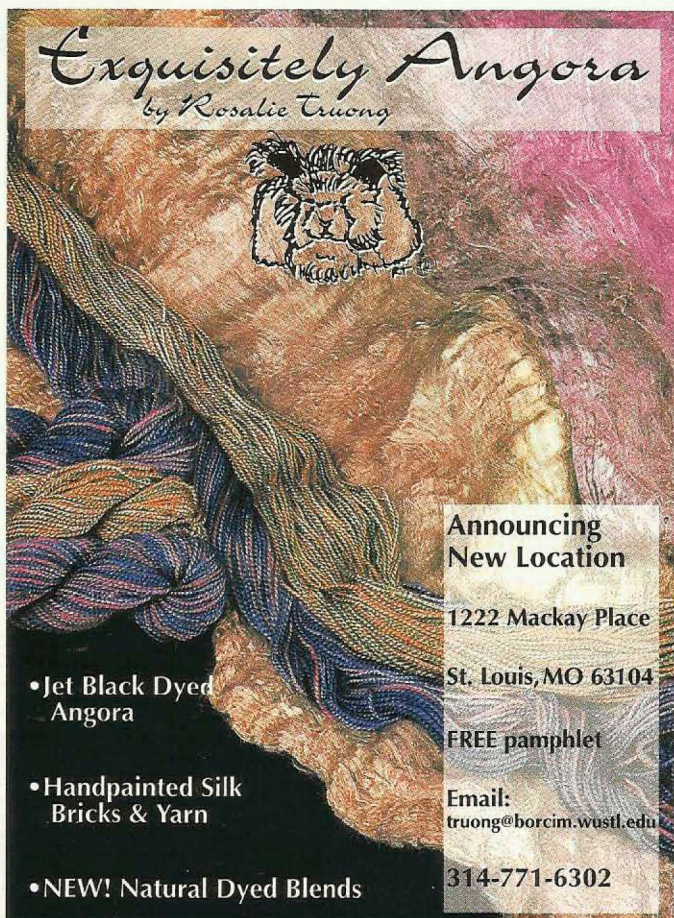

Announcing
New Location

1222 Mackay Place
St. Louis, MO 63104

FREE pamphlet

Email:
truong@borcim.wustl.edu

314-771-6302

- Jet Black Dyed Angora
- Handpainted Silk Bricks & Yarn
- NEW! Natural Dyed Blends

Especially for Ewe!

We stock the yarns featured in this issue!

Order your kit today!

1-800-933-9665

Andean Artistry • A Natural Flair
Opposites Attract • Sideway Seed Jacket
Purple Passion Sweater • Shawls - Marilyn - Nancy

Barbara Walker

books are back in reprint.

All three editions are available now.

**Order first and second editions
and receive the third edition at**

1/2 price!

THE WOOL CONNECTION

34 East Main Street, Avon, CT 06001



1-860-678-1710 • Fax 860-677-7039

http://www.woolconnection.com E-mail: wool@tiac.net

HIGH TECH KNITTING

A LOOK AT SOFTWARE FOR KNITTERS

Tara Jon Manning

HANDKNITTING REQUIRES exceptional patience, a love of fiber and color, and appreciation for the age-old process of building a one-of-a-kind piece stitch by stitch, row by row. While the art of handknitting may seem at odds with the pace of life in the late twentieth century, many knitters find refuge from the buzz and noise with their beloved needles.

In this age of electronic information and cyber everything, many of us find ourselves nose-to-glass with a computer screen more often than we may have ever imagined possible. Although some traditionalists call it sacrilege, the computer is an exceptional tool for knitting design. In fact, the past few years have seen the development of powerful yet easy-to-use personal knitting computing tools. These programs aid in everything from creating a basic schematic and pattern to advanced custom color charting. Novice knitters and accomplished designers alike can use preprogrammed shapes or customize silhouettes in an instant. And a scanner can convert images into charted patterns.

Here is an overview of some of the knitting resources available for use with a computer. Each program is accessible to different proficiency levels of computer users, knitters, and designers. Please note that due to space limitations, not all features of each program are covered in depth.

I approached this evaluation by trying to use the programs to design a sweater I had already designed the old-fashioned way—with a calculator and graph paper. The “control” sweater is an oversized Aran pullover knitted a few years ago. I soon discov-

ered that the computer programs require one overall gauge, not the many that Aran panels dictate. So I simply used the overall measurements of my control sweater as a guide. Interestingly, achieving the same results with each program required very different computerized journeys.

When you’re investigating computer software for knitting design, asking yourself the following questions may help you choose the right program for you.

- What kind of computer setup do you have? Understanding the importance of minimum system requirements is crucial. If you have an older machine, software written for new systems may run frustratingly slow, if at all.
- What will you use the program for? Do you want to chart patterns for color knitting? Do you want the program to spit out a complete pattern for you? Do you want to be able to manipulate garment outlines or design from scratch?
- What is your level of computer proficiency? What is your level of knitting proficiency? You may be an exceptional knitter, but feel that you’ve been run over on your way to the information highway. Conversely, you may be a computer whiz, but new to needles and yarn. Some programs are best suited to whiz-bang computer users. Others allow for one’s knitting skill to develop with use. Consider these factors as you contemplate your knitting software purchase. Software is costly, and buying a program that will make you so frustrated you decide to use the disks as coasters does no good.

STITCH PAINTER 2.0

Available from Cochenille Studios

Price: \$165.00

www.cochenille.com

This diverse and powerful program for Mac or PC allows fiber artists to create charts using colors, symbols, textures, or combinations of all three. Knitters, weavers, beaders, crocheters, cross-stitchers, or anyone who uses a grid in their work will love this easy-to-use program.

Stitch Painter allows you to look at a design and modify color choices as you go. Fair Isle knitters can change one yarn color at a time to preview its impact on the design as a whole. The program also includes clever repeat functions, allowing for motif repeats, stamping, or flip-

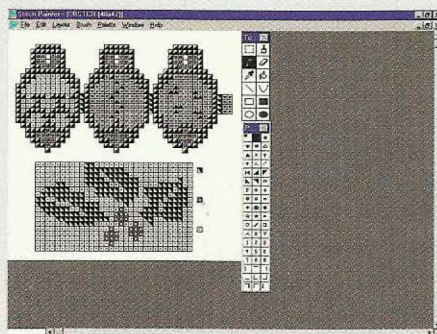

ping and reversing a design component.

Like other charting programs, the symbol palettes include standard knitting symbols. Users can combine these to create a library of frequently-used symbols, or create their own symbols.

The color palettes in Stitch Painter are impressive. You can create custom

colors and combine colors with symbols or textures. You can also merge custom palettes from two or more designs.

Here are just a few more of the hundreds of fun and helpful features available in Stitch Painter:

- You can use background colors to preview a two-color or tweed yarn.
- To save memory, you can crop charts to the size of an image, so only a single motif rather than the entire grid need be saved.
- You can customize defaults to your preferences.
- You can layer grids.
- Re-grid option (gold version only) allows you to draw a design and then change the grid size without changing image size. The new grid will be superimposed over the image and will re-

calculate the number of stitches and rows. This allows you to use the same design with different-size yarns, or convert a graph for use in a different media, such as turning a cross-stitch graph into a knitting graph.

- You can use clip art or make your own custom library of images and motifs.
- You can set grids to be square or rectangular in shape.
- Stencil option, a powerful and complicated tool, allows areas of color to

be masked so you can continue to draw in and over the entire image without altering the masked section.

- You can import images from paint or scan programs. When pasted into Stitch Painter, one pixel equals one stitch. This means the image fits into the grid perfectly.

Stitch Painter is accompanied by a complete, fully-illustrated, and easy-to-use manual. Over 100 pages long, it details installation and includes a features overview,

and a comprehensive self-guided tour of the program. If you're using Windows 95, you may experience a glitch in printing. A patch and troubleshooting instructions are included with the program. The program does not feature on-line help, but the manual extensively covers all program aspects. The Cochenille website offers the company's e-mail address for simple questions and tips for using Stitch Painter, as well as information on upcoming seminars and events.

SYSTEM REQUIREMENTS	Mac: Macintosh System 6.05 or higher, 4 MB RAM. PC: Windows 3.1 or higher, 4 MB RAM, VGA graphics card.
COMPUTER SKILL	Familiarity with pop-up and tear-off menus highly recommended.
KNITTING/DESIGN SKILL	Beginning knitter with basic design skills.
USER INTERFACE	Menus are well-organized and full of options. Large working area and moveable palette.
MANUAL	Comprehensive and fully-illustrated. Over 100 pages with easy-to-use index. Includes tutorials.
DESIGN OPTIONS	Easy translation of motif into grid. One pixel = one stitch.
CUSTOMIZATION OPTIONS	Custom blend colors. Build custom symbol library from basic blocks.
ADD-ON PROGRAMS	Sister program to Garment Styler. Import designs from Styler for embellishment. Import scanned images.
QUALITY OF WRITTEN PATTERN	No written pattern. Charts are best with color printer but can be printed in gray scale and combined with symbols.
TECHNICAL SUPPORT	No on-line help. Website features e-mail address and tech help. Help also available via telephone.

GARMENT STYLER

Available from Cochenille Studios

Price: \$85.00

www.cochenille.com

Garment Styler is an in-depth and multi-option apparel design program for creating hand or machine knitwear, sewn garments, quilt blocks, and loom-shaped wovens. This is a very comprehensive, intuitively designed program that is accessible to all skill levels of designers and knitters who are comfortable with computers. It is available for use on Mac or PC.

The Garment Styler screen layout is very user friendly. When the program opens, three option bars run above a display of garment choices. With the option bars you can choose a standard size or create a custom size. The size selected is represented by a sloper (basic bodice shape) that sits inside the garment as it is designed, allowing you to visualize fit and appearance relative to body measurements. The sloper can be seen or hidden as you work.

The manual states that over 10,000 combinations of styles are available.

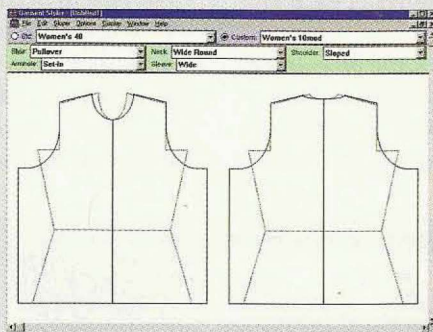

These include choice of style for garment, armhole, neck, sleeve, and shoulder. Your choices are immediately reflected in the garment outline display, lending a neat element of instant gratification to the process. Garment Styler also automatically calculates sleeve caps, for which it claims excellent accuracy.

Pre-programmed ease allowances ranging from three inches (fitted pullover) to nineteen inches (oversized cardigan) are built in to each garment style. Finished designs can be exported to a paint program such as Stitch Painter for embellishment or motif placement.

The program does not create a written pattern, per se, but rather prints out a chart with detailed shaping instructions applicable to machine knitting, hand-knitting, or weaving. The program is accompanied by a "cheat sheet" on how to read the chart and adapt it into a hand-knitting pattern, and the chart is fully explained in the manual. Future versions will also feature written patterns and more garment style options.

The Garment Styler manual is very well written and easy to follow. Generously illustrated, it is full of tutorials and lessons, complete explanations of all program menus, special sections addressing each of its user groups, and a chapter on "Creative Techniques . . . or How to Fudge." This chapter offers several "creative controls", ways to get around some of the preprogrammed options within the program in order to develop unique and customized garments. These controls are similar to those available in other programs, such as DesignaKnit, but are thoroughly documented and explained, which makes them much more user friendly. One important

note: many of the functions and features available in Garment Styler require multiple commands. This may be frustrating for a non-computer person, but the manual does offer detailed instructions on how to complete each procedure successfully.	
SYSTEM REQUIREMENTS	Mac: Macintosh System 6.05 or higher, 4 MB RAM. PC: Windows 3.1 or higher, 4 MB RAM, VGA graphics card.
COMPUTER SKILL	Familiarity with pop-up and tear-off menus highly recommended.
KNITTING/DESIGN SKILL	Beginning with willingness to sort through technical pattern chart.
USER INTERFACE	Option bars at top of screen. New selections immediately reflected on garment in display area.
MANUAL	Comprehensive and fully illustrated. Includes extensive troubleshooting.
DESIGN OPTIONS	10,000 possible combinations. Garment, armhole, neck, sleeve, and shoulder choices. Sweaters, jackets, dresses, and more.
CUSTOMIZATION OPTIONS	Customization may be tricky, but extensive help is offered in the manual.
ADD-ON PROGRAMS	Export designs to Stitch Painter for embellishment. Clip art available.
QUALITY OF WRITTEN PATTERN	No written pattern. Detailed chart with numeric information.
TECHNICAL SUPPORT	No on-line help. Website features e-mail address and tech help. Help also available via telephone.

DESIGN-A-PATTERN

Available from Ileen's Needle Nook
Price: \$75 each/\$240 all four

Design-A-Pattern, written for the machine knitter, allows you to create machine-knitting patterns from a choice of garment styles and types. It generates a text pattern based on custom measurements. The pattern is adaptable to handknitting; instructions for adapting the patterns are included in the manual, but knowledge of machine knitting may help in translating this data.

After you create a basic pattern outline with the desired measurements, the Design-A-Pattern Wizard calculates shapings, stitches, rows, increases, and decreases. The pattern text can be printed from the screen or sent to a word processing program for editing and reformatting.

Design-A-Pattern includes options

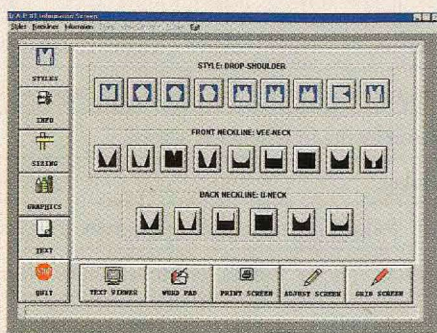

for designing pants and skirts. It also lets you overlay a grid on pattern outlines and export them to paint programs for further embellishment. Design-A-Pattern can make a yardage estimate based on either the weight or the length of a knitted swatch.

The user interface of this program is a little clunky, and its multiple screens have you jumping around a bit. None-

theless, it has a lot to offer if you're comfortable moving from screen to screen to get at it.

The manual is a twenty-page instructional portfolio. It contains complete instructions for installation, step-by-step use of the program, definitions of all screens and commands, sample patterns, instructions on how to take proper measurements, and more. Although thorough, the manual is an informal technical document, which at times means it's hard to follow. It does not contain a table of contents or an index, but its brevity allows for thumbing through. The program does not offer on-line help, but users are encouraged to contact Ileen's Needle Nook for help and questions. A demo version is available on disk for review before purchase, and it includes sample patterns. Registered users receive new product updates as soon as they are available.

SYSTEM REQUIREMENTS	PC 486 or higher. Windows 3.1 or higher. 4 MB RAM, SVGA graphics.
COMPUTER SKILL	Familiarity with Windows. Requires changing screens frequently.
KNITTING/DESIGN SKILL	Handknitters should understand machine knitting and basic design vocabulary.
USER INTERFACE	Option-packed screens can be awkward to navigate.
MANUAL	Comprehensive twenty-page portfolio.
DESIGN OPTIONS	Sweaters, pants, waistcoats, and more. Can handle vertical and horizontal knitting.
CUSTOMIZATION OPTIONS	Custom measurements easily entered into size boxes.
ADD-ON PROGRAMS	Program comes with four "volumes". One has sweaters, another skirts, etc.
QUALITY OF WRITTEN PATTERN	No written pattern. Guidance for adapting for handknitting available in manual.
TECHNICAL SUPPORT	Help is available via telephone.

THE SWEATER WIZARD

by Carole Wulster
Available from Patternworks
Price: \$89.95
www.patternworks.com

This easy-to-use software offers pre-programmed sizes and styles to which you may apply preferred gauge and needle sizes. It presents line-drawn schematic detailing measurements, numbers of rows, and stitches. It prints out a complete written pattern, including an estimate of yarn yardage. The Sweater Wizard allows

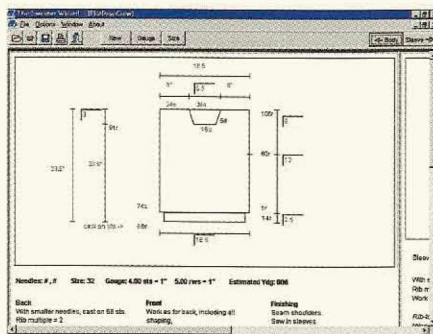

you to customize a garment from the schematic screen by entering preferred

measurements and updating the written pattern accordingly. This program is well suited for all skill levels of knitters, adapts to a range of design skills, and is accessible to even the computer-phobic. The option to knit the sleeves from the top down, as this reviewer prefers, is a good feature, and the next version of Sweater Wizard will feature options for short sleeves. Future versions will be thirty-two-bit programs for Windows 95 and above; there will be no new additions to the Windows 3.1 version.

SYSTEM REQUIREMENTS	Windows 3.1 or 95. Less than 1 MB hard disk space, 1.5 for the install. Min. 8 MB RAM for best performance. New version will be for Windows 95 and above only.
COMPUTER SKILL	Basic knowledge of Windows.
KNITTING/DESIGN SKILL	Beginning knitter with basic design skills.
USER INTERFACE	Presents schematic as line drawing. Side-scrolling screen. View one piece at a time.
MANUAL	Eight-page comprehensive leaflet. Includes pictures of screen display and tips.
DESIGN OPTIONS	Cardigan, pullover, crew, or v-neck. Flat or circular knitting. Five sleeve styles.
CUSTOMIZATION OPTIONS	Enter specific measurements in schematic screen.
ADD-ON PROGRAMS	Stitch & Motif Maker.
QUALITY OF WRITTEN PATTERN	Concise and easy to follow. Includes yardage estimate. Prints one page for each pattern piece.
TECHNICAL SUPPORT	Help is available via telephone. E-mail sent to the author was answered promptly and thoroughly.

STITCH & MOTIF MAKER

by Carole Wulster
Available from Patternworks
Price: \$89.95
www.patternworks.com

This program for charting out stitch patterns is an add-on to The Sweater Wizard as well as a stand-alone program. It has the same no-nonsense feel and quick learning curve of The Sweater Wizard.

The symbol library has over sixty knitting symbols based on International/Japanese symbol language. It does not, however, contain any stitch symbols more than two stitches wide. This means a four-stitch rope cable requires three individual symbols: the basic two-stitch right-twist symbol plus a knit at the back

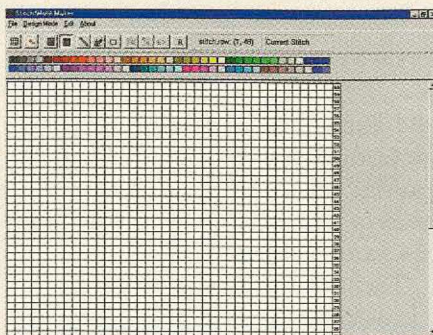

and front stitch added on both sides. You can, however, design a basic library when you begin a chart and then copy and paste multiple stitch cables and sequences as needed. The documentation enclosed with the program details how to construct cable stitches using multi-

ple symbols. This leaflet also displays a key that defines all the symbols, and provides examples of charted designs and complete installation instructions. Charted designs and motifs can be copied into the Windows Clipboard and pasted into other Windows programs.

The color charting option features a palette of seventy-four colors. To add color to a graph, you click on the color, then on the square you want colored. Both the color and symbol palettes use a click-and-drag fill, allowing you to fill several squares or a large area with the same symbol or color at one time. Unfortunately, the program uses a square rather than rectangular grid—you'll have to knit a swatch to see how knitted fabric will look.

SYSTEM REQUIREMENTS	Windows 3.1 or higher. Less than 1 MB hard disk space, 1.5 for the install. Min. 8 MB RAM. New version will be for Windows 95 and above only.
COMPUTER SKILL	Knowledge of Windows.
KNITTING/DESIGN SKILL	Beginning knitter with basic design skills and understanding of charts.
USER INTERFACE	Easy toggle between symbol and color libraries. Toolbars offer shortcuts.

MANUAL	One-page insert is surprisingly comprehensive.
DESIGN OPTIONS	Seventy-four preprogrammed colors and over sixty symbol building blocks.
CUSTOMIZATION OPTIONS	Color palette can be expanded. Personal library of symbols can be created.
ADD-ON PROGRAMS	Sister program to The Sweater Wizard. Chart can be pasted into other Windows applications.
QUALITY OF WRITTEN PATTERN	Chart is clear and easy to read, but image is not scaleable.
TECHNICAL SUPPORT	Help is available via telephone. E-mail sent to the author was answered promptly and thoroughly.

DESIGNAKNIT

Available from Knitcraft Incorporated
 Price: \$360 professional
 \$285 standard
www.knitcraft.com

DesignaKnit is an impressive program for machine knitting that can be used by handknitters willing to work without a written pattern. DesignaKnit provides many options in three modes—Standard Garment Setup, Custom Garment Drafting, and Stitch Designer. The program also features an Interactive Knitting Mode—it uses sounds and spoken instruction and provides a cable connection to your knitting machine for garment production. You can convert graphic files from outside sources into charts in Stitch Designer mode—simply lay a grid on the image and scale it to desired size.

The program takes advantage of Windows' user-friendly options such as advanced toolbars and color layouts. The Custom Garment Drafting mode, for example, is well-suited to users who are ex-

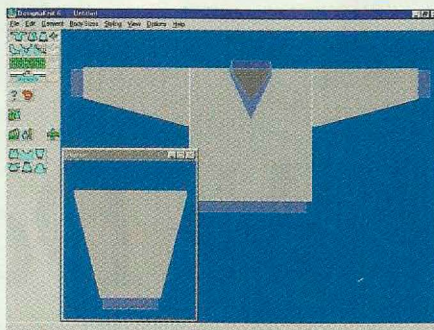

perienced with flat pattern design and CAD (Computer-Aided Drafting) programs. This mode is not, however, well-suited to the recreational computer user, nor the seasoned user unfamiliar with drafting programs.

Customizing the shapes and styles available in Standard Garment Mode may be a bit irksome. The program is very specific, requesting body measurements and exact amount of ease. My "control" sweater was very long and oversized—twenty-seven inches across and twenty-nine inches long. The circum-

ference was the same at the hip and shoulder. I attempted to manipulate the body-measurements screen by entering the finished garment sizes as the body measurement and setting the ease to 0.0. The program would not let me get away with this, popping up error messages such as "shoulder too wide for waist." I had to do a lot of manipulating both to make the program happy and the overall measurements add up the way I wanted them.

The depth of features available within this program is remarkable. However, the manual does not offer support for handknitters, and the program does not produce a written pattern. But handknitters can use the schematics and notations as visual patterns, accompanied by color blocks or symbol instructions. Beginning knitters, or those with little patience for symbol languages or sitting in front of the computer, will have a hard time with this. Generating a print-out is a bit complicated too. These points are unfortunate, since the power of this program is dazzling.

SYSTEM REQUIREMENTS	PC 386, 486 or Pentium. Windows 3.1 or higher. 4 MB RAM, SVGA graphics (VGA acceptable). 6 MB hard disk space.
COMPUTER SKILL	Intermediate to advanced. Experience with CAD (Computer Aided Drafting) recommended.
KNITTING/DESIGN SKILL	Beginning to intermediate. Knowledge of pattern drafting would be helpful.
USER INTERFACE	Illustrated, easy-to-use toolbar. Choice of color or monochromatic display. Schematic features shading and contrasting color seams.
MANUAL	Extensive 105-page technical manual, well organized and indexed. Does not address adaptive uses for handknitters.
DESIGN OPTIONS	Various garment, sleeve, and neck styles. Curves and angles available with toolbar. Stitch Designer for color palette and symbols.
CUSTOMIZATION OPTIONS	Easily create original garments from scratch. Instructions on custom use in manual.
ADD-ON PROGRAMS	Three modes act as add-ons to one another. Converts graphics from other programs.
QUALITY OF WRITTEN PATTERN	No written pattern. Block schematic and details are complicated.
TECHNICAL SUPPORT	Comprehensive and searchable on-line help. Help also available via telephone. Tips at website.

Tara Jon Manning recently completed her Master's thesis on the history and design of Aran knitting. She lives near Boulder, Colorado, with her husband, son, dogs, and cat.



Susan



Amy



Jillian

Nancy

Shawl We Dance?

OUR CHALLENGE for this issue was to knit a shawl with a luxury fiber. We all used the Garter Lace Triangle Shawl pattern from *Traditional Knitted Lace Shawls* by Martha Waterman (revised edition, Interweave Press, 1998), and the edging or finishing of our choice.

GARTER LACE TRIANGLE SHAWL

Stitches

Garter-Stitch Band:

Rows 1, 3, and 5: (RS) K1f&b (knit into front and back of st), knit to last st, k1f&b—2 sts inc'd.

Rows 2, 4, and 6: Knit.

Rep Rows 1–6 for pattern.

Lace Band:

Rows 1 and 3: (RS) K1f&b, k1, *yo, k2tog; rep from * to last 2 sts, k1, k1f&b—2 sts inc'd.

Rows 2 and 4: K3, *yo, p2tog; rep from * to last 3 sts, k3.

Rep Rows 1–4 for pattern.

Shawl: CO 4 sts. Knit 1 row. Alternate Garter-Stitch Band and Lace Band until the piece is desired length, inc 1 st each end of needle every RS row, and ending with Garter-Stitch Band. You can widen either band by 2, 4, or 6 rows, if desired. BO all sts loosely to maintain elasticity. (Alternatively, you can finish the piece with a narrow knitted-on border.)

Finishing: Block, stretching piece to open up lace pattern. Add edging if desired.

Susan Strawn Bailey, illustration

I would say that I learned a lot making this shawl, but that's what I say when I really dislike doing something. It's better to say that I knitted this shawl because I want it, not because the simple pattern is interesting to knit. I added a picot eyelet border as a small reward. Since the photograph was taken, I've added another border ("Ocean Waves" from *Traditional Knitted Lace Shawls*). Surprisingly, the edging progressed quickly.

I used 4 balls of Schoolhouse Press Icelandic Laceweight Wool (100% wool; 240 yd [219 m]/50 g), color #0013 dusty sage on size 6 (4 mm) needles. I ended with a stitch count of 294 and a finished size of about 64" (162.5 cm) wide by 33" (84 cm) long. I alternated 8 rows of the Garter-Stitch Band with 4 rows of the Lace Band. My edging is composed of eyelets worked in groups of 3 on a St st background. Work eyelets as follows:

Row 1: K2tog, yo twice, sl 1 kwise, k1, pssso.

Row 2: Knit to "yo twice" of previous row, p1, k1.

Amy Clarke, editorial

When I started this project I wondered what I would do with the shawl once I was done—I really couldn't see it fitting into my wardrobe. But since I like knitting for the sake of knitting, I forged ahead. Then as I knit, romantic notions and images of shawl-bearing heroines began to frequent

my imagination—Carmen, Jane Eyre, Catherine (running to meet Heathcliff), and Tess of the D'Urbervilles. By the time I finished my shawl, I couldn't get the theme song from Carmen out of my head. I bought a CD of Gypsy ballads and began a second shawl.

I used 3 skeins of Aurora Yarns Silke Tweed (52% silk, 48% lambswool; 219 yd [200 m]/50 g), color #18 teal on size 4 (3.5 mm) needles. I ended with a stitch count of 278 and a finished size of about 53" (134.5 cm) wide by 29" (73.5 cm) long. I alternated 6 rows of the Garter-Stitch Band with (Row 1 of the Lace Band, knit 1 row) 2 times.

Jillian Moreno, publishing

I love my shawl; it's feminine without being prissy, and lacy without being fragile. To help show off the subtle color changes in the handpainted yarn, I doubled the number of rows in the lace bands. I wish the shawl were bigger (I ran out of yarn and time), but that's probably because I watched *Like Water for Chocolate* while knitting it!

I used 2 skeins of Fisher's Angora Rabbitry Handpaints (60% angora, 35% wool, 5% silk; 360 yd [329 m]/4 oz), color midnight sapphire on size 7 (4.5 mm) needles. I ended with a stitch count of 248 and a finished size of about 64" (162.5 cm) wide by 35" (89 cm) long. I alternated 6 rows of the Garter-Stitch Band with 8 rows of the Lace Band.



Jennifer



Ann



Marilyn

Judith

Nancy Disney, editorial

I wasn't going to knit a shawl. I was too busy. The single-color superfine alpaca and wool was soft, but seemed plain next to the luscious colors and fancy yarns the others were using. I wanted to knit quickly and I wanted the lace pattern to be distinct. I tested the pattern on size 7 and 9 needles before deciding to knit on size 10 (6 mm). For variation, I worked the lace band in different widths. I dressed up two-edges with a four-inch fringe.

I used 5 balls of Cascade Yarn Lana D'Oro (50% superfine alpaca, 50% wool; 110 yd [101 m]/50 g), color #210 berry. I ended with a stitch count of 180 and a finished size of about 60" (152.5 cm) wide by 33" (84 cm) long, plus a 4" (10-cm) fringe around two edges. I alternated 6 rows of the Garter-Stitch Band with 8, 6, and then 4 rows of the Lace Band.

Jennifer Nastu, marketing

These days, I love things that are ultra-feminine. What could be more perfect than a soft, smoky-blue shawl? I added two extra rows of lace for a double dose of girliness, and tried to picture myself wearing it. But a thought intruded—it would make a perfect shower gift for Carmen, my brother's blonde and petite fiancée (not to be confused with the dark-haired spitfire of Amy Clarke's imagination). I immediately banished this picture from my head. But the more I worked on the shawl, the more it became Carmen's, no matter how hard I thought of it as my own. Oh, sigh. It's no use fighting a project that has a mind of its own. I packed it up and sent it off.

I used 3 skeins of Chasing Rainbows Dyeworks (80% angora, 20% silk, hand-

spun; 170 yd [155 m]/50 g), color moody blues on size 9 (5.5 mm) needles. I ended with a stitch count of 200 and a finished size of about 52" (132 cm) wide by 31" (79 cm) long. I alternated 6 rows of the Garter-Stitch Band with 6 rows of the Lace Band.

Ann Budd, editorial

I'm told my office is climate-controlled; I say it's freezing. So I was glad to knit a shawl that I could throw over my shoulders or lap. The worsted-weight yarn is somewhat bulky, but the mohair/wool content keeps it surprisingly light and drapery. I was afraid that an edging would be too much so I simply tied tassels to the three corners (they're great fun to twirl). But there can be too much of a good thing—the shawl is so big that my desk chair rolls over the ends.

I used 6 balls of Bryspun kid-n-ewe (50% kid mohair, 50% wool; 120 yd [110 m]/50 g), color #450 garnet on size 9 (5.5 mm) needles. I ended with a stitch count of 224 and a finished size of about 70" (178 cm) wide by 35" (89 cm) long. I alternated 4 rows of the Garter-Stitch Band with 4 rows of the Lace Band and finished by attaching one 4½" (11.5-cm) tassel to each corner.

Marilyn Murphy, editorial

This yarn is an absolute dream—luscious to touch and very lightweight and warm. I stuck to the pattern without any variation because I knew I didn't have the patience to knit too many eyelets. Plane rides and visiting family and friends over a very long weekend was exactly the length of time I needed to finish my shawl.

I used 2 balls of K1C2 Solutions Douceur et Soie (70% baby mohair, 30% silk; 225 yd [206 m]/25 g) in #146 natural on size 3 (3.25 mm) needles. I ended with a stitch count of 244 and a finished size of about 47" (119.5 cm) wide by 26" (66 cm) long.

Judith Durant, editorial

I did not jump into this endeavor with the enthusiasm I usually muster for our staff projects. You see, I'd just finished knitting this very shawl to be photographed for the book. Been there, done that. I thought about fibbing and using that original shawl and telling you it was knitted with some luxury fiber rather than the wool/nylon blend I actually used. But then I wouldn't be able to sleep at night, and if I don't sleep at night I get cranky and fall down on the job. So I picked up my needles and this delicious American Cashmere. And am I glad I did! I share that cold office with Ann Budd, and this lightweight and wonderfully soft shawl provides the necessary warmth and looks great, too.

I used 2 skeins of Cashmere America (100% cashmere, 2-ply; 437 yd [400 m]/50 g) in natural brown on size 3 (3.25 mm) needles. I ended with a stitch count of 290 and a finished size of about 59" (150 cm) wide by 31" (79 cm) long. I added the Narrow Van Dyke lace edging from *Traditional Knitted Lace Shawls*, which I knitted separately and attached. ∞



To order *Traditional Knitted Lace Shawls*, call 800-645-3675, dept. A8K1; \$21.95 plus s&h.

Artfibers
www.artfibers.com
 "INSPIRATIONAL...A HAVEN!"
 VOGUE KNITTING
 CD-ROM CATALOG/SAMPLES \$5
San Francisco
 124 Sutter 888.326.1112

COLOR TRENDS

...for your natural dye needs

- 15 quality natural dye extracts & their fixatives
- Tagua nut buttons, for dyeing, in all sizes & styles
- Bone buttons for your handmade garments
- Handspun agave bath products, dyed & undyed
- Handspun nettle shawls, placemats & coasters

FOR MORE INFORMATION CONTACT US AT: COLOR TRENDS
 DEPT. KN3 • 5129 BALLARD AVE. NW • SEATTLE, WA 98107
 PHONE: 206-789-1065 • FAX: 206-783-9676

Cat Cuddler Kit

Knit, then felt a warm cozy place for your kitten, cat or small dog to nap. Kit includes wool yarn, and instructions for a small (or med). \$34.95 (49.95) plus shipping. Specify shades of blue, purple, green, red, black & white or custom colors. Pattern \$6 PPD (MI residents add 6% tax) (Intern'l: additional postage)

Threadbender Yarn Shop

2767 44th SW
 Wyoming, MI 49509
 616-531-6641 or 888-531-6642 (orders)

KOIGU WOOL DESIGNS

Grape Punch Cardigan
 Koigu Sheep 2ply
 KIT CDN\$98

Koigu Wool Designs
 RR1 Williamsford, Ont.
 519-794-3066

100% Angora & Angora Blends

Now available from USA's Top Breeders of Angora Rabbits!

All Angora Wool is Hand Spun making it Shed-Resistant. Great Colors to Choose From. We Feature Angora/Merino & Angora/Alpaca Blends. Fuzzy, Soft, Warm & Irresistible! New Kits Available: Berets, Socks, Muckluks, House Shoes, Gloves & many more. Send \$3.00 for samples, refundable with order!

Happy J Farms 409-387-2521
 PO Box 214, Dept I, Beasley, TX 77417

Fiber Trends®

Hand Knit Designs
 New
 Classy Bows

Chenille hat in toddler, child & adult sizes

See the Full Line of Fiber Trends' Patterns
 At Your Favorite Yarn Store

Retailers, for wholesale information contact:
Bryson Distributing @ 1-800-544-8992 or Fiber Trends @ 1-888-733-5991

Fiber Trends • P.O. Box 2634 • Bellingham, WA 98227-2634 • Phone (360) 733-5997 • Fax (360) 733-4896



Hanney Kennedy & Sons Meadowcroft Farm

A high-luster yarn blend with Merino and mohair. Hand dyed in seawater in the sun. From our Organic Hillside farm in Maine. Send SASE (52¢) for color sample.

45 HOPKINS ROAD
WASHINGTON, MAINE 04574
(207) 845-2587 (PHONE/FAX)

Celebrating the Dazzling Array



MAFA
'99

1999 Summer Conference
Bucknell University
Lewisburg, PA • July 5-11

Join us for classes on:
WEAVING—Madelyn van der Hoogt
SURFACE DESIGN—John Marshall
KNITTING—Kathryn Alexander
TAPESTRY—Archie Brennan
SEWING—Daryl Lancaster
SPINNING—Alden Amos
DYEING—Bety Vera
over fifty others!

Please request a registration brochure from:
Judy Anderson
Mid-Atlantic Fiber Association
RR2, Box 214, Lewisburg, PA 17837
email: mafa99@ptd.net

Check out our MAFA web page
<http://www.mafafiber.org>

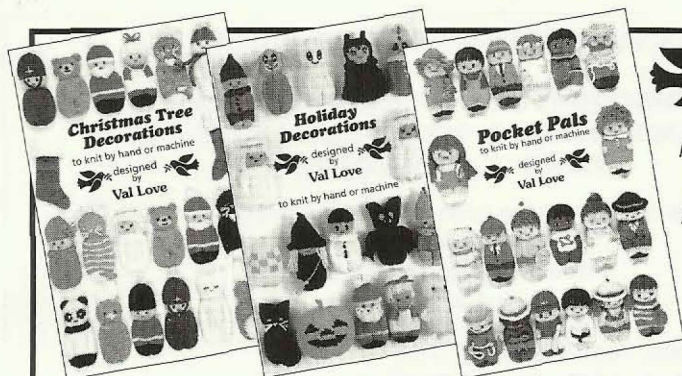

Dovetail Designs

For information about knitting and crochet pattern books and kits by Val Love, visit your favorite yarn shop or contact Dovetail Designs.

Retailers contact BRYSON DISTRIBUTING at: 1-800-544-8992 or
Dovetail Designs, PO Box 1163, NY, NY 10028 • (212)534-4976 • Fax (212)722-6324 • valove@att.net



FIBER KINGDOM

luxury fibers and colors to delight your senses

FROM THE NORTH COUNTRY OF NEW YORK STATE

- ☞ Unique natural fiber yarns hand-dyed in harmonious color palettes
- ☞ Original design kits
- ☞ Special buttons, dyes, books, Addi Turbo needles
- ☞ Luxury fibers and equipment for spinners, weavers, felters
- ☞ Workshops, personalized instruction

SEND LSASE FOR PRODUCT INFORMATION TO:

SYLVIA GRAHAM, FIBER KINGDOM BOX 654 EAST BROADWAY
SALEM, N.Y. 12865 518 854 7225 PHONE/FAX

2 NEW Knitting Pattern Books by Betty Lampen

"Knitted
Teddy Bears
& Dolls"



"Best Dressed
Teddy Bears"
Book 3
of "Sweaters for
Teddy Bears"

Betty Lampen, Dept IK
2930 Jackson St.

San Francisco, CA 94115-1007
Books \$7 each—postage included
CA residents include tax. US funds only.
<http://www.bettylampenknitbooks.com>

DESIGN SOFTWARE

- **Garment Styler**
for knitting instructions & sewing patterns \$85.
- **Stitch Painter**
for gridded knit & craft design \$85./\$165.

Cochenille Design Studio
P.O. Box 234276 - C
Encinitas, CA 92023-2342
(619) 259-1698

Windows & Macintosh
catalogue \$1.
<http://www.cochenille.com>

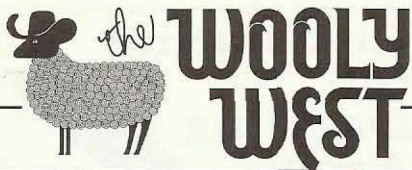

**Fine natural
fiber yarns and
accessories for
handknitters**

*We specialize in
small projects!*

*Everything from
yarns and patterns
to books and needles.*

Mailorder Catalog
Send or call for our free catalog.

1417 South 1100 East
Salt Lake City, UT 84105
(801) 487-9378

SpinCraft
*the handspinner's
craft patterns*
SpinCraft, Box 327
Salmon, ID 83467
FREE CATALOG
(Catalog requests 10am-6pm)
(208) 756-3076
spincraft@aol.com

"Knit so it Fits"

Use any yarn—make it *your* size. It's easy: Take a measurement, find your gauge, add it up, follow the directions. YOU are the designer!

Start with these collections: \$12.50 ea
• Best Vests • Best Sweaters • Best Hats

Accomplish even more—subscribe to
• SpinCraft Pattern Newsletter \$12

NEW BOOK: **Spindle Spinning: From Novice to Expert**
The best way to start spinning your own yarn. Fun instructions make it easy.
• By Connie Delaney: \$12 + 3 s&h (autographed copy!)



WE'RE SERIOUS ABOUT YARN

GREAT DISCOUNTS * UNMATCHED SERVICE
NAME BRAND YARNS * WEBS' EXCLUSIVE YARNS
TERRIFIC CLOSEOUTS

See why thousands of knitters have been buying natural fiber yarns from Webs for over twenty years

Introductory samples \$2.00

Tell us you saw our ad in *Interweave Knits*



Webs, Yarn Merchants
P.O. Box 147 - Service Center Road
Northampton, MA 01061-0147



A tip of the
chinchilla tam to
Myrna Stahman
for her lovely lace
designs using

Viva! Chinchilla.

Catalog including yarns, kits, roving
& raw fibers: \$3.00

Special introductory offer:
Bootee kit & catalog: \$7.50
(please add \$1.50 for S & H)

One kit per customer. Expires 12-31-98



(206) 463-2004

Creature Comforts

PO Box 606 Vashon, WA 98070

E-mail: viva@csn.org

Web-site: www.nwrain.net/~viva



the mannings Handweaving School & Supply Center



1132 Green Ridge Rd
PO Box 687
East Berlin, PA 17316
717-624-2223

ORDERS - 1-800-233-7166

We stock what every knitter needs: Knitting Books (189 titles), patterns from Ann Norling, Fiber Trends, Woolen collectibles, etc., yarns from Brown Sheep, JCA, Henry's Attic, Renaissance, Tahki, Plymouth, Skacel, etc., knitting needles, NEW wooden cable needles, and a large selection of the popular sock yarns. \$2.50 FOR CATALOG AND YARN STYLE CARD



Knit Patterns for Modern 18 Dolls & Soft Animals*

Lots of Different Collections

For detailed pattern information, please send a SASE to:

Close Knit Press

POB 1500, Campton, NH 03223-1500

Voice: 603 726-4700
Fax: 603 726-8818
e-mail: dolls@tecorp.com

* Popular dolls 18"-20"
including American Girl®
from Pleasant Company
* Bears & bunnies 16"-18"

For color pictures see web page <http://www.tecorp.com>

CLASSIC SWEATER KITS AND YARNS

Featuring Yarns from New England/Canada, Norway & Iceland, Authentic Guernsey Wool from England, Jo Sharp Yarns & Books, Rowan Kits & Yarns, Shetland and Aran Yarns

IN THIS ISSUE (ALL PRICES PPD)

Andean Artristry \$65/73/73/85
 Cradle Blanket \$46
 Couch Blanket \$104
 A Natural Flair \$65/70/75
 Opposites Attract \$68/68/68/84
 Purple Passion Pullover \$151/166/181
 Sideways Seed Jacket \$65/77/89/89
 St. Honoré \$202/202/241/241

Strands of Pearls Pullover \$50/50/56/68
 (yarn only)
 Lace Shawls
 KidNEwe \$30
 Cashmere \$65
 Douceur et Soie \$30
 Lana D'Oro \$21

Visit us on the World Wide Web www.barkim.com or e-mail your order to barkimltd@aol.com

BARKIM LTD.

47 West Polk St., Suite 100-303, Chicago, IL 60605
 Toll Free Orders! 888/548-2211 FAX 773/624-3380

VISA/MC

AMEX/DISC

The Wooden Cable Needle

Natural wood with
 grooved center*
 holds stitches
 better than
 aluminum
 "hook" or "J"
 needles...

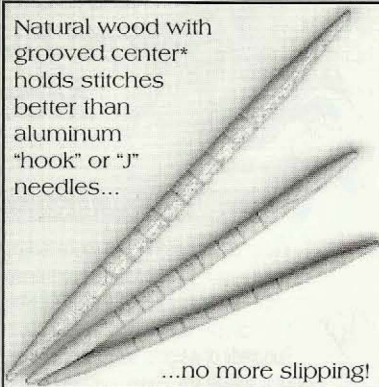

...no more slipping!

Ask For The Wooden Cable Needle
 at your local yarn shop.

or order direct from FibreTECH

Small (use with needle sizes 1-5) \$3.00

Medium (use with needle sizes 5-8) \$3.50

Large (use with needle sizes 8-up) \$4.00

Set of all three - best value! \$10.00

Shipping & handling included!

CA residents include sales tax

MC, VISA, Discover, Personal Checks accepted

~ Wholesale inquiries welcome ~

FibreTECH

Specialty products for the fiber artist

248 Harbor Blvd., Belmont, CA 94002

phone 650 610 0555 fax 650 610 0557

e mail FibreT@aol.com

* patent pending

★ PERSONAL SERVICE ★ EXPERT FINISHING ★

AYLIN'S WOOLGATHERER 1-800-775-WOOL

GREAT SELECTION OF EXQUISITE YARNS FROM ALL OVER
 THE WORLD. HUNDREDS OF BUTTONS.

AREA'S LARGEST COLLECTION OF PATTERN BOOKS.
 ROSEWOOD & EBONY, ADDI, AND CLOVER NEEDLES.

Look us up on Internet: <http://www.aylins-wool.com>

AYLIN'S

7245 ARLINGTON BLVD., FALLS CHURCH, VA 22042 • (703) 573-1900

Ask for our brochures

INSTRUCTIONS

INSTRUCTIONS

★ EXPERT FINISHING ★ PERSONAL SERVICE ★

NORWEGIAN SKI SWEATER & HAT

KNITTING PATTERN SIZED FOR BEARS, DOLLS AND CHILDREN

by Judith Shangold



Call

888-566-9970

for catalog of knitting patterns
 for dolls & bears
 & a supplier near you

A BEAR IN SHEEP'S CLOTHING

PO BOX 770, DEPT I, MEDFORD, MA 02155

An Adventure in Intarsia Knitting

Sweaterscapes for every kind of knitter

We also offer simple solid color & textured
 sweaters, landscape sock kits, and books.

Reasonably priced wool yarn kits.

Ask for our free color catalog
 or visit our complete on-line catalog at
www.sweaterscapes.com

Borealis Sweaterscapes

95 Hessian Hill Road, Cornish, ME 04020
 207-625-8955 • borealis@cybertours.com

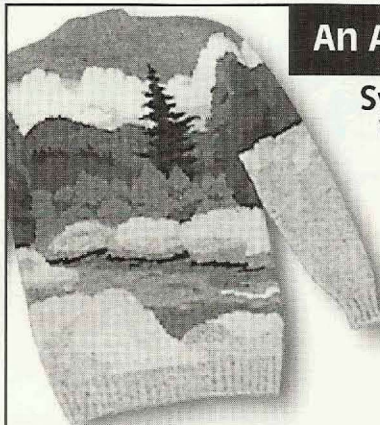

Don't use
 a million pins
 when you
 block!

Just insert
 these rustproof,
 stainless Blockers
 along the edge of
 your unfinished
 knitted pieces.

The Blockers
 stop the curling
 and smooth the
 knitted fabric so
 you can easily
 pin and steam to
 your desired
 measurements.

\$18.50
 plus \$3.95 sh

Blocker's Kit includes:

- 8 (36") & 4 (18") rigid Blockers
- 2 flexible 27" blockers for curves.
- 1 cm/in yardstick • 30 T-pins
- Blocking instructions

**Fiber Fantasy Knitting
 Products Ltd.**

6 Hunters Horn Court-Dept IK
 Owings Mills, MD 21117

1-800-242-Knit (5648)

Visa • Mastercard • Discover • Am Exp



Cotton Yarn by Mail

Call Us Toll Free!

We'll put the cotton yarns you're looking for – and more – right into your hands. Our catalog has it all! Over 1500 colors of cotton and cotton blend yarns in hundreds of weights, sizes and textures. Unique knitting kits, books, patterns, videos and tools. All with quick delivery, friendly service and a 100% Satisfaction Guarantee! Save with our bulk discounts, introductory offers and weekly specials. Plus the \$5 cost of this catalog with yarn samples is refundable with your first order.

Mail to: **Cotton Clouds**
5176 South 14th Ave., Dept IK-98
Safford, AZ 85546-9252

Enclosed is \$6.50 (PPD) for catalog & samples

**COTTON
CLOUDS**

Name _____
Address _____
City _____ State _____ Zip _____

Credit Card Orders 800-322-7888



4 Green Hill Rd. • P.O. Box 504
Washington Depot, CT 06794

Specializing in natural fiber yarns
for knitting from the following:

- Rowan
- Classic Elite
- Tahki/Stahl
- Skacel
- Lane Borgosesia
- Berroco
- Plymouth/Cleckheaton
- Sirdar
- Anny Blatt
- Katia
- Grignasco
- Noro
- Brown Sheep
- Muench

and more!

And . . . hand painted needlepoint from the country's leading designers, with a complete selection of fibers, including Persian wools, silks, cottons, metallics and novelty fibers.

Expert Finishing Services Available. Call for
more information and our free brochure

1-800-371-1014

Featheridge Designs

4 Green Hill Rd. Washington Depot, CT 06794
Tues.-Sat. 10-5 • MC/VISA/DISC.





**Have you ever knit a
Babies & Bears
Sweater?**

*The perfect sweater for newborn
to twenty-four months.
And, it's seamless!*

Pattern is \$6.00 ppd. Visa/Mastercard
515-324-1280
Or send LSASE for brochure.

**Cottage Creations
At the Farm on Deer Creek
Carpenter, IA 50426-0070**

Knit with the Best...

Join the Knitting Guild of America now and get a subscription to *CAST ON* magazine and much more!

- Innovative Designs
- Great How-To Articles
- Knitting News
- Master Knitting Programs for Hand and Machine
- 1999 National Convention in **San Diego, CA**, March 17-21, 1999
- Fabulous Conferences for 1998 in: **Tacoma, WA**—July 31-Aug. 2; **Springfield, IL**—Aug. 21-23; **Colorado Springs, CO**—Sept. 25-27; **Andover, MA**—Nov. 11-15.

To join TKGa send a check for \$23
(\$30 for Canada and Mexico, \$38 for all others)
to TKGa at the address below or
call 1-800-274-6034 to use Visa or MasterCard.
For information, please call (423) 524-2401 or
see our web site at <http://www.tkga.com>
**TKGa, Dept. IK5 • P.O. Box 1606 •
Knoxville, TN 37901-1606**



Name _____
City _____ St _____ Zip+4 _____
Telephone _____
E-mail _____
MC VISA Exp. date _____

PRODUCT NEWS

Jillian Moreno

Vogue Knitting Designer Knits

Edited by Trisha Malcolm

Butterick Publishing Company, \$30.00

For decades, *Vogue Knitting* has been on the cutting edge of fashion knitting.

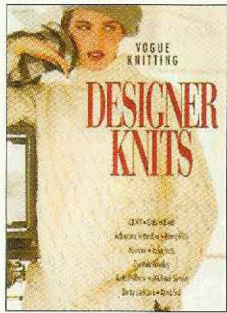

Designer Knits is a collection of greatest hits from the eighties and nineties. Forty-five designs by twelve of fashion's best-known designers have been chosen for their timeless appeal

and variety of skill level. From Donna Karan's "Enchanted Forest" cardigan, to Perry Ellis's "Bubble Sweater", to Betty Jackson's "Pony Print Pullover" there is something for every knitter. This oversized book has full-color photography and tips on selecting yarn, reading patterns, and following charts. All patterns have been updated with currently-available yarns. This is just the ticket to jump-start knitters into the fall knitting season.

Available from your local yarn shop or Butterick (800) 766-3619.

A Treasury of Knitting Patterns

A Second Treasury of Knitting Patterns

Charted Knitting Designs: A Third Treasury of Knitting Patterns

Barbara G. Walker

Schoolhouse Press, \$30.00 each

Run, do not walk, to your favorite knitting store. Christmas has come early for all knitters! The three Barbara Walker

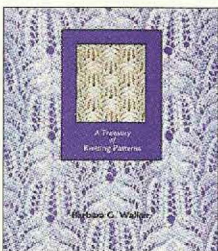

pattern treasuries are back in print. This collection of books has attained mythical status among knitters all over the world as the indispensable source for pat-

terns. Between the three, there are 1,550 patterns at your fingertips organized by stitch type—lace, mosaic, texture, and

rib. No knitter's library is complete without these treasures.

Available from your local yarn shop or Schoolhouse Press (800) 968-5648.

Head to Toe Knits:

25 Colorful Accessories for Your Child and Your Home

Zoë Mellor • Trafalgar Square, \$22.95

Color, color, color! There is no doubt that Zoë Mellor loves color. She brings her unique sense of color and light-hearted motifs to classic designs. Need to enchant a child in your life? There are kids' hats, backpacks, socks, and toys. Need to brighten up your home? Try Zoë's rich colors on pillows, blankets, rugs, and throws—there's even a knitted lampshade. This book is especially charming for knitters who want to try colorwork on a small scale and knitters who must have portable projects.

Available from your local yarn shop or Trafalgar Square (800) 423-4525.

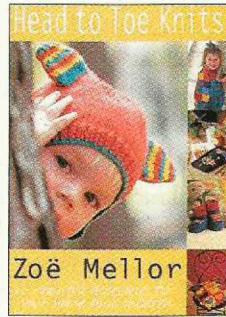

basic mitten design, and then presents an abundance of fine and breathtakingly colorful mitten, cuff, and pattern designs to mix and match as your imagination determines. Forty-two complete mitten patterns are presented in beautiful full-color photography. Beyond the patterns, this book offers finishing and embellishment techniques, linings, an extensive resource guide, blank charts, and encouragement to design your own mittens.

Available from your local yarn shop or Unicorn Books (800) 289-9276.

Family Knits:

Over 25 Knitwear Designs for Babies, Children and Adults

Debbie Bliss • Trafalgar Square, \$22.95

Finally! Debbie Bliss has heard the knitters who love her kids' patterns but want them in adult sizes. In her latest book she sizes all her patterns from a child's small to an adult's large or extra large. The designs are classic Debbie Bliss, from a feminine Fair Isle cardigan with a lace edge to a sturdy-wear, everyday Guernsey. This book is as lovely to look at as it is easy to knit from with full-color photos that illustrate the designs and easy-to-follow patterns with easy-to-read charts.

Available from your local yarn shop or Trafalgar Square (800) 423-4525.

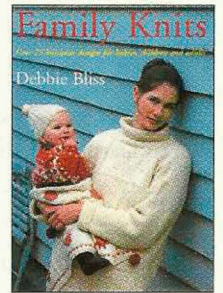

Magnificent Mittens:

The Beauty of Warm Hands

Anna Zilboorg • XRX, \$29.95

Magnificent indeed, this is a beautiful book. Any knitter who has considered making mittens should take a good look

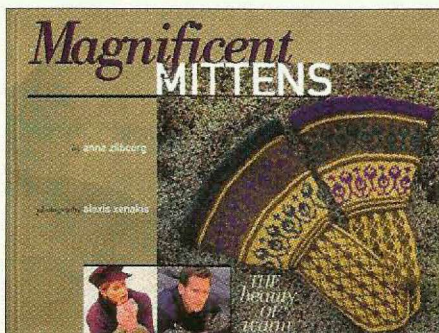

at this book. It walks you through the basics of mitten knitting, including a

Baby Mocs Kit: Viva! Chinchilla

Looking for a unique and quick baby project? How about Chinchilla booties? These ultra soft booties are made from a blend of chinchilla, silk, and merino. They are knitted on size 5 double-pointed needles, with such an easy pattern that even beginning knitters can finish a pair in a single evening. Even a baby who has everything probably doesn't have Chinchilla mocs! ∞

Available from Creature Comforts (206) 463-2004. \$7.50 plus \$1.50 shipping and handling.

Knits

Your thoughts, please...

Every now and then it's a good idea to take the pulse of our readers to make sure we're giving you what you want in a knitting magazine. It's helpful to know not only what you think, but a little bit about who you are. We invite you to share your thoughts and information. We look forward to hearing from you.

- How long have you been knitting?
 - less than a year
 - 1-5 years
 - 6-15 years
 - more than 15 years
- What level knitter do you consider yourself?
 - beginner
 - intermediate
 - advanced
 - expert
- What knitting techniques would you like to learn more about?

- Where do you get your information about knitting techniques, supplies, and materials?
 - books
 - magazines
 - friends
 - knitting or craft store
 - mail order
 - the Internet
 - other (please specify)

- How much do you spend on knitting supplies per month?
 - less than \$50
 - \$51-\$100
 - \$101-\$300
 - more than \$300
- How many projects do you knit in the summer?
 - less than 3
 - 3 to 5
 - more than 5
- What fiber(s) do you knit with in the summer?

- Please rank the following from 1 (not important) to 5 (very important):

projects	1 .. 2 .. 3 .. 4 .. 5
new techniques	1 .. 2 .. 3 .. 4 .. 5
- Do you prefer:
 - quick, easy projects
 - more complex projects
 - projects from kits with materials included
- What crafts do you do other than handknitting? (mark all that apply)
 - spinning
 - embroidery
 - weaving
 - needlepoint
 - sewing
 - crocheting
 - beading
 - cross-stitch
 - dyeing
 - tatting
 - machine knitting
 - other (please specify)

- Where do you purchase your knitting supplies?
 - knitting shop
 - general craft shop
 - mail order
 - other (please specify)

- How many hours a week do you spend knitting?
 - 1-5
 - 6-10
 - 11-15
 - more than 15
- What inspires you to start a new project?
 - yarn
 - pattern
 - style
 - technique
 - other (please specify)

- Are you a subscriber to *Knits*?
 - yes
 - no
- If not, where did you purchase this copy?
 - newsstand
 - craft shop
 - bookstore
 - ordered by mail
 - other (please specify)

- What do you like best about *Knits*?
 - projects to make
 - new techniques
 - behind the scenes with a designer
 - historical articles
 - articles about knitters
 - other (please specify)

- How often do you respond to ads in *Knits*?
 - every issue
 - frequently
 - occasionally
 - never
- What is your annual household income before taxes?
 - less than \$30,000
 - \$31,000-\$50,000
 - \$51,000-\$75,000
 - more than \$75,000
- What is your occupation?

- Are you _____ female _____ male?
- What year were you born? 19____
- What are the first three digits of your zip code?

- What level of education have you completed?
 - less than high school
 - high school
 - trade or vocational school
 - college degree
 - advanced degree

Thank you for your time and help—it will make a difference. Please return this survey to *Interweave Knits*, 201 East Fourth Street, Loveland, CO 80537-5655.



You have the book, now you
can have yarn kits for
some of the mittens!
Don't have the book?
\$29.95, free shipping
thru 9/30/98

190 Eastridge Rd., Ridgeway, VA 24148
Info: (540) 957-1174

Anna Zilboorg's MAGNIFICENT MITTENS Kits

The hand dyed colors (to Anna's specifications) are rich and glowing, the mohair/merino blend yarn is gloriously lustrous and smooth (same as she used in her book), the angora lining yarn is delectable, and the patterns for these *gauntlet mittens* are intricate, exciting, and - well, *magnificent!*

Kits now available for
the following mittens:

4-3 \$58
4-10 \$50
5-3 \$50
5-4 \$50

(5-4 includes beads)

6-7 \$58

Child \$25

(child: *assrt'd colors*)

and a few others; inquire.

Angora lining yarn: \$15

3 sets 5 ea. DP birch needles

(sz 4, short & long, sz 7 long): \$12

**Scoured, undyed yarn:
\$16/8-oz skein**

KIT ORDER LINE:

(800) 450-7786

Visa, MC, AmEx, Discover

SPINNING - WEAVING - KNITTING - DYEING

Equipment, supplies, books, videos, and more!

Catalog: \$2. Color card, kit info: \$2.

ADVERTISERS' INDEX

A Bear in Sheep's Clothing	77	Kruh Knits	51
A Stitch Above	23	L'Atelier	ifc
Amazing Threads	27	Lambspun of Colorado	27
Artfibers Gallery	74	Lampen, Betty	75
Aurora Yarns	10	Lion Brand Yarn Co.	38
Aylin's Woolgatherer	77	Lorna's Lace	22
Barkim, Ltd.	77	Louet Sales	53
Berroco	9	Mannings, The	76
Borealis Sweaterscapes	77	Meadowcroft	75
Brittany Company	62	Michigan Fiber Festival	66
Brown Sheep Company	39	Mid-Atlantic Fiber Assn '99	75
Carolina Homespun	81	Mountain Colors	23
Close Knit Press	76	Muench Yarns	17
Coats Patons	bc	Nancie Knits	53
Cochennille Design Studio	75	Needlepoint Joint, The	62
Color Trends	74	Patternworks	53
Cottage Creations	78	Personal Threads Boutique	66
Cotton Clouds	78	Plymouth Yarn Co.	21
Creature Comforts	76	Rovings	3
Crystal Palace Yarns	30	Samuel Charis Knits	63
Dale of Norway	15	Schaefer Yarns	38
Dovetail Designs	75	Schoolhouse Press	17
Eucalan, Inc.	23	Sealed With A Kiss	27
Exquisitely Angora	66	Shuttles, Spindles & Skeins	17
Featheridge Designs	78	Skacel Collection	10
Fiber Fantasy	77	Spincraft Pattern Newsletter	76
Fiber Kingdom	75	Stone Fox Fibre Works	16
Fiber Trends	71	Tahki Yarns	7
Fibretech	77	Threadbender Yarn Shop	74
Halcyon Yarn	ibc	Unicorn Books & Crafts, Inc.	63
Haneke Wool Fashions	47	Victorian Video	51
Happy J Farms	74	Web*Sters	42
Harrisville Designs	58	Webs	76
Heirloom Woven Labels	42	Westminster Fibers	35
Ileen's Needle Nook	58	Wilde Yarns	10
Interweave Press	4, 22, 31, 43, 65	Woodland Woolworks	58
Joseph Galler, Inc.	23	Wool Connection	66
K1C2 Solutions	10	Wooly West	76
Knitting Guild of America	78	Yarn Barn	62
Knitting Traditions	35	Yarns International	11
Koigu Wool Designs	74		

SOURCES FOR SUPPLIES

(W) = Wholesale (R) = Retail

YARNS

Yarns used in this issue are available through your local retail store or mail-order company. If you are unable to locate the supplies, below is a listing of the U.S. distributors. Write to them for a retail source.

- (W) Aurora Yarns, 2385 Carlos St, PO Box 3068, Moss Beach, CA 94038. (650)728-2730. E-mail: aurorayarns@pacbell.net.
- (W) Berroco Inc/Lang, 14 Elmdale Rd, PO Box 367, Uxbridge, MA 01569.
- (W) Brown Sheep Company, 100662 County Rd 16, Mitchell, NE 69357.
- (W) Bryson Distributing, 4065 West 11th Ave #39, Eugene, OR 97402.
- (W) Cascade Yarns, PO Box 24326, Seattle, WA 98124.
- (R) Cashmere America Cooperative, PO Box 1126, Sonora, TX 76950. (915) 387-6052.
- (R) Chasing Rainbows Dyeworks, 2220 Hilltop Dr, Willits, CA 95490. (707)459-5680.
- (R) Creature Comforts, PO Box 606, Vashon Island, WA 98070. (206) 463-2004.
- (R) Creskeld Guernsey/ Knitting Traditions, PO Box 421, Delta, PA 17314. (717) 456-7950.
- (W) Dale of Norway, N16 W23390 Stoneridge Dr, Ste A, Waukesha, WI 53188.
- (R) Fisher's Angora Rabbitry, 17790 Hodown Lane, Frenchtown, MT 59834. (406) 626-5806. E-mail fisher@bigsky.net.
- (W & R) Haneke Wool Fashions 630 North Blackcat Rd, Meridian, ID 83642.
- (W) K1C2 Solutions, 2220 Eastman Ave #105, Ventura, CA 93003.
- (W) Lorna's Laces, PO Box 795, Somerset, CA 95684.
- (W) Muench Yarns/GGH, 118-Ricardo Rd, Mill Valley, CA 94941-2461.
- (R) The Musk Ox Company, 633 Fish Hatchery Road, Hamilton, MT 59840. (406) 363-6818.
- (W) Plymouth Yarn/Cleckheaton, PO Box 28, Bristol, PA 19007.
- (W & R) Schoolhouse Press, 6899 Cary Bluff, Pittsville, WI 54466.
- (W) Skacel/Schoeller Esslinger, 4224 SW 12th St, Renton, WA 98055.
- (W) Tahki Yarns/Austermann, 11 Graphic Pl, Moonachie, NJ 07074.
- (W) Unique Kolours/Cynthia Helene, 1428 Oak Lane, Downingtown, PA 19335.
- (W) Westminster Fibers/Rowan Yarns, 5 Northern Blvd, Amherst, NH 03031.

SOFTWARE PROGRAMS

- Cochennille Design Studio, PO Box 234276, Encinatas, CA 92023. (619) 259-1698.
- Ileen's Needle Nook, 4106 W. Ely Rd, Iannibal, MO 63401. (800) 221-6665; (573) 221-9456.
- Knitcraft, Inc., 500 N. Dodgion Ave, Independence, MO 64050-3023. (816) 461-1217.
- Patternworks, PO Box 1690, Poughkeepsie, NY 12601. (800) 438-5464; (914) 462-8000.

The Knits Resource Guide

Knitters! Weavers! Crocheters!

Try a product that's warmer and more durable than wool, hypo-allergenic, luxurious, and lightweight!

- Fine Quality Llama & Alpaca Yarns
- Alpaca/Llama/Merino Blend Yarns
- Rovings and Raw Fiber

Sample cards available upon request: \$5.00 CDN, \$3.75 US

The Canadian Llama and Alpaca Fibre Co. Ltd.

291 Long Harbor Rd., Salt Spring Island, B.C.
CANADA V8K 2K9. Ph/fax: (250) 537-9446

www.islandnet.com/~rkrieger/guide.html • mkriegeralpaca@saltspring.com



Lustrous Yarns from Long Stapled Corriedale and Mohair Wool
77 Natural & dyed Colors Sample Card \$10.00

Bear Hill Farm

Integrity in Wool

13 Bear Hill Road ~ Bozrah, CT 06334 ~ (860)889-1719

Est. 1730

Sonja Pedersen Fuller

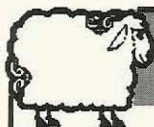

Ewe & Eye

GREAT PRICES ON BROTHER KNITTING MACHINES

♥ \$1989—Stitch Leader KH970—Top of the Line
6 colors, 9 motifs, 665 patterns

♥ \$1599—KH9651—New—Regularly \$2195

♥ \$549—KG95—Automatic Garter Carriage

\$100 in supplies Free with Purchase of any Knitting Machine with KG95

Toll Free 1-888-249-2083

512 River Road ♥ Boerne, TX 78006 ♥ VISA/MC Will ship

SPINNER'S HEARTH

Becky and Joe Scellato
7512 Lackey Rd., Vaughn, WA 98394
(253) 884-1500 • e-mail: spinners@narrows.com



FOR ALL YOUR KNITTING & SPINNING NEEDS

Alice Starmore • Annabel Fox • Berroco • Brown Sheep
Classic Elite • Creative • Crystal Palace • Cynthia Helene
Dale of Norway • Green Mountain • Manos • Mountain Colors
Muench • Patons • Peer Gynt • Plymouth
Philosopher's Wool • Tahki/Stahl

Lots of kits - Socks, Shawls, Vests & Sweaters

Join our Sock-of-the-Month Club and
Manos Afghan Square-of-the-Month Club

Fine Quality Yarns

Silk yarn \$52/lb	Kid Mohair buckled yarn,
Cashmere yarn \$52/lb	made in Italy, beautifully
Cashmere/silk yarn \$52/lb	rainbow dyed \$99/lb
Camel down yarn \$52/lb	Baby Alpaca yarn color . . \$75/lb
Yak down yarn \$52/lb	Merino yarn natural . . . \$15/lb
Virgin Wool yarn color . \$38/lb	Mill end novelty yarns
Egyptian cotton yarn . . \$60/lb	closed out \$5/lb
Silk Chenille Yarn \$62/lb	

Luchi Yarns, 1055 E. Paramount Pkwy., Batavia, IL 60510
(630) 761-9674. \$10.00 for sample color card.

Affordable hand-dyed Yarns from...

Colorflow



EJ Merino - Bohus yarn packs

Over 70 colors of 100% wool in 4 weights

PO Box 477 • Warren, IL 61087-0477
(800) 492-0221



100% WOOL YARNS

Blues, laurels, roses & greens—79 warm colors—heathers, all-naturals, solids, marls, tweeds. Lanolin-rich, pure wool. Ideal for classic sweaters, cozy caps & mittens. Thrifty 4-oz. skeins. Ask us for dealer names & FREE color packs.

PURE WOOL
Since 1821

Bartlettyarns, Inc.

Box 36-KS8 Harmony ME 04942 207/683-2251

Hanne Falkenberg • Schaefer • Clover • Classic Elite • Lang • Unger •



1208 Ridge Road
Raleigh, NC 27607
919-832-3599

e-mail greatyarn@gte.net

VISIT OUR NEW WEB SITE FOR INFORMATION
ABOUT SPECIALTY AND UNUSUAL YARNS
FROM AROUND THE WORLD.

www.great-yarns.com

Order Line 1-800-810-0045

Swedish Yarns • Wendy

Cynthia Helene • Muench

• Adrienne Vittadini • Filatura Di Crosta • Berroco • Collinette •

The Knits Resource Guide

COUPEVILLE ARTS CENTER

KNIT RETREATS ON WHIDBEY ISLAND

■ **RUSSIAN LACE KNIT RETREAT** ■ **ETHNIC KNIT RETREAT**
 October 16-18, 1998 April 9-11, 1999
 Galina Khmeleva Joan Schrouder

Coupeville Arts Center PO Box 171KN Coupeville, WA 98239
 (360) 678-3396 FAX (360) 678-7420 cac@whidbey.net
<http://www.coupevillearts.org>

Bette Bornside Company
Yarns and knitting supplies since 1986

Free shipping on orders over \$30
 1-800-221-9276 VISA/Mastercard

Berroco, Brown Sheep, Cleckheaton, Classic Elite, Ironstone, Lion, MacAuslan, Plymouth, Reynolds, Renaissance, Rowan, Tahki, Trendsetter, Unger, Vittadini

Catalogue: \$4

2733 Dauphine St., Desk WK, New Orleans, LA 70117

 **RAINBOW RIDGE SWEATER PACKAGES**
Raglan pullover sweater knit in the round. White with raised rainbow ridges.
 Child 2-4 yr \$32.50 • 4-6 yr \$38.50
 Adult M \$72.50 • L \$78.50 • XL \$84.50

HANDSPUN & Naturally Dyed YARN
 20 yards each of seven colors
 100% WOOL - \$12
 worsted weight
 ANGORA /WOOL (50/50)
 \$19 worsted & sport weight

JAMIE HARMON
 175 Barber Road Box K • Jericho, VT 05465

SAMPLES & BROCHURE \$4



Beautiful Bolivian ALPACA YARN

100% alpaca yarn in 90+ colors!
 sport weight 2 oz., 2-ply, 115 yard skeins

\$6.20 per skein, \$4.34 per skein for orders over 50+ skeins

Send \$2 and SASE legal size envelope for color/sample card to:
 Blue Sky Alpacas, P.O. box 387, St. Francis, MN 55070
 888-460-8862, e-mail: bluesky@visi.com, web site: <http://pradparken.com/bluesky/>

ADDI • BRITTANY • CRYSTAL PALACE
 NEEDLES & HOOKS
Free Price List Available

Garden City Stitches
 FINE YARN • NEEDLEWORK

725 FRANKLIN AVENUE GARDEN CITY, NY 11530
 (516) 739-KNIT 5648



INCA PUNTA HAT KIT
 \$30.00 ppd. Choose 4 colors.

GEOMETRIC HAT KIT
 \$25.00 ppd. Choose 3 colors.

Both hats made with Dale "Tuir": 40% mohair, 60% wool—soft, lightweight—14 colors

Three Kittens Yarn Shoppe
 805 Sibley Memorial Hwy., St. Paul, MN 55118
 1-800-489-4969 mail-orders welcome



Trendsetter • Colinette • Tahki • Classic Elite • Prism

Knitting Fever **Stahl** **Plymouth • Crystal Palace**

100% cashmere & 100% silk yarns

WE'RE MORE THAN A YARN SHOP!!
Yarns By Design
 247 E. Wisconsin Ave., Neenah, WI 54956
 (920) 727-0530
 Toll Free 1-888-55-YARNS
Knitting, Spinning, Weaving, Classes
 Product Listing \$1.00

Located in historic Victorian home across from Neenah Harbor — MON., THURS., FRI. 10-8; TUES., WED., SAT. 10-5



Alice Starmore • Dale of Norway • Cochenille Design Software

NANCY FINN, 2220 HILLTOP DR., WILLITS, CA 95490 • (707) 459-5680

See our yarn used in the
"Shawl We Dance" staff project

Chasing Rainbows Dyeworks

The Knits Resource Guide

KnitSource™

The *ultimate* source directory for knitting, crochet, and all fiber arts, organized in a way that will save you time, money and more importantly, make you more creative.

➤ **Thousands of sources** for mail order suppliers, web sites, retail stores, clubs, charities and more

➤ **Exclusive** free offers, savings and discount coupons

Only \$21.95 (plus \$3.00 S&H). Send check/money order to: Vision Knit, (IK), 3150 S. Greythorne Way, Chandler AZ 85248
Visit our web site at <http://www.visionknit.com>

You bought the best yarn.
You conjured up your most interesting creative thoughts.
You labored for hours using your finely honed knitting skills.
Now for that finishing touch...
Unusual buttons for the discriminating knitter.

THE BUTTON SHOPPE buttons by mail

14 page color catalog \$5.00 (refundable)

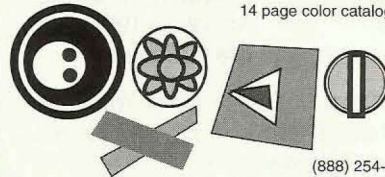

The Button Shoppe

Dept. 0209
4744 Oakfield Circle
Carmichael, CA 95608

(888) 254-6078 FOR CREDIT CARD ORDERS

Knit with our soft wool yarn!

Over 50 Heather Tones, Tweeds, and Vibrant Shetland colors. worsted, sportweight, and bulky. In 4-oz Skeins.

Affordable Price! Order directly from the farm producing fine wool fleece of *Corriedale* sheep.

Yarn samples \$3.
Refundable with order
MasterCard/VISA

1186 Jarvis Branch Rd.
Mars Hill, NC 28754
828-689-9931

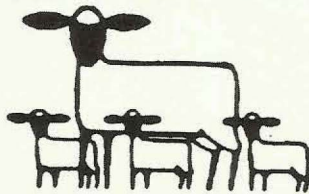

BOVIDAE FARM

Pamper Yourself...

Luxurious AMERICAN CASHMERE

from herds all across America



100% CASHMERE Yarn
CASHMERE Blend Yarns
Ready-To-Spin CASHMERE Fiber

To order, call/write:

CASHMERE AMERICA COÖPERATIVE

P.O. Box 1126, Sonora, TX 76950,
(915) 387-6052 (Tu or Th)
or a Dir. at (360) 424-7935 (WA), or (207) 336-2948 (ME)



cherry tree hill yarn

handpainted yarns for the fiber fanatic in us all!
terrific textures unforgettable colors

p.o. box 254
east montpelier
vermont 05651

(802) 229-0831
www.cherryarn.com
email: orders@cherryarn.com

Check out our website for free downloadable patterns, free shipping and samples of all yarns and colorcards. Or send LSASE and \$4 for new fall sampler, brochure, newsletter and kit list.

SOFT WOOL YARN

Merino-Rambouillet fine grade wool

Worsted & Sport weight

Natural & Dyed colors

Skeins & Cones

3 colors **100% CHEMICAL FREE**



Send Long SASE for free brochure and color samples to:

MARR HAVEN

772 - 39TH ST., DEPT IK ALLEGAN, MI 49010
(616) 673-8800 • <http://www.accn.org/~mhyarn>

New Zealand
Knitting Needles
SP pr. 2 thru 11
DP swt/4-2 thru 8
\$4.75 pair or set
plus \$4 shipping



♥ Grand View Country Store ♥

U.S. Rt. 2 Randolph, NH 03570

A UNIQUE YARN SHOP!

All the best is right here in the scenic White Mountains of New Hampshire. Add us to your travel agenda or send \$3.00 to subscribe to our Newsletters of yarns, books and original knitting kits. Free knitting pattern in each.



Come for "2 Days in a Yarn Shop!"
"Mountains, Muffins and Mohair"
Lodging available. 1-800-898-5715

OUR INTERWEAVE PATTERN COLLECTION

1. Neck down Cable Yoke Cardigan
2. Sampler V-Neck Vest—5 colors
3. Sampler Stitch Cardigan
4. Sampler Pullover—Him or Her
5. Classic Sampler Jacket
6. Cable V-Neck Vest
7. Neck down Pullover/Child
8. Neck down pullover/Adult

All knit in Worsted Wt Yarns
Patterns \$3.50ea + \$1.25ea/s/h

Complete kits also available
1-603-466-5715

Your Creations are Your YarnExpressions

come to us for project materials from

Alice Starmore

Bartlett yarns

Berocco

Brown Sheep

Classic Elite

Dale of Norway

Lorna's Laces

Plymouth Yarns

Skacel Collection

Tahki/Stahl

Trendsetter

Unique Colours

we feature Michele Wyman patterns

ORDER LINE 1-800-283-8409

Yarn Expressions 7914 S. Memorial Pkwy., Huntsville, AL 35802

visa/ master card/discover

e-mail: mmanning@ro.com

The Knits Resource Guide

NATURAL FIBER YARNS

including ROWAN, TAHKI, VITTADINI, ELITE, REYNOLDS, PHILDAR, etc.

Plus first-quality mill ends

Send \$5.25 for complete mail order sample card of over 500 colors and textures

Periodic Updates • Quantity Discounts

Also Available: Exotic fiber sample card, approx. 150 samples of silks, angoras, ribbons & exotics. \$2.75

Bare Hill Studios/Fiber Loft (retail)

Box 327, Rt. 111 (P.O. Bldg), Harvard MA 01451 • 1-800-874-YARN



Moonrise offers a lace-teaching kit...

Lace Sampler Scarf in wool/silk with 12 patterns written in Lace Shorthand

#3 needles: Easy flat lace knitting. Many colors—Please give 2 color choices. Send check or money order w/ \$4 shipping to:

MOONRISE

2804 Fretz Valley Rd • Perkasio, PA 18944-4033
Ph/Fax (215) 795-0345 • E-mail Sandy_at_Moonrise@juno.com
Free Brochure

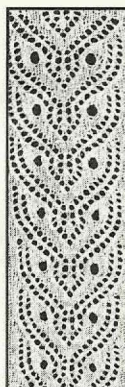

Blackberry Ridge Woolen Mill, Inc.

Wonderfully Soft Yarns from our Mill
Offering Yarns, Knitting Kits, and Patterns

New for 1998!

Sock of the Month II

Free catalog listing yarns and products.

Yarn Samples \$3.00

Visit our web site at <http://www.blackberry-ridge.com>
3776 Forshaug Road Mt. Horeb, WI 53572
(608) 437-3762



Tahki • Classic Elite • Great Adirondack

A Garden of Yarn

This exquisite Norah Gaughan pullover has intricate cables throughout and is available in twelve captivating colors.

Ask for Classic Elite's Pattern #695
1-888-226-KNIT

Come see us at:

Stitches, Oct. 23-25, booths 233/334
Penn. Quilt Extravaganza, Sept. 17-20



Prism • Rowan • Jodi's • Noro & many more



basketry
book arts
dyeing
knitting
papermaking
spinning
surface design
textile arts
weaving

the weaving works

4717 Brooklyn Ave NE
Seattle, WA 98105

supplies/classes/books

orders: 1-888-524-1221 info: (206)-524-1221 fax: (206)-524-0250

Create an HEIRLOOM AFGHAN

... and learn a host of skills along the way!
Join The Knitting Guild of Canada and participate in the MASTER KNITTER PROGRAM.

You'll also get KNITTERS' FORUM magazine quarterly. Fee is \$34/yr in Canada; \$34 U.S. for mailing outside Canada. VISA/Mastercard/cheques accepted

Write: TKGK, Box 549, St. George, ON, Canada N0E 1N0
tel 519-442-4150; fax 519-442-4673
email bootsie.ckc@sympatico.ca

Join other knitting nuts by joining TKGK today!

The Fiber Studio

New Hampshire's Leading Fiber Arts Store

- ◆ Looms ◆ Spinning Wheels ◆ Large assortment of fibers to spin & felt ◆ Natural fiber knitting & weaving yarns ◆ Hand-painted rayon chenilles
- ◆ Bamboo & wood needles ◆ Unusual beads & buttons

Yarn Samples \$5.00/set
Spinning Fiber Samples \$4.00/set Catalog \$1.00

9 Foster Hill Rd., PO Box 637, Henniker, NH 03242
603-428-7830 Open Tues-Sat, 10-4 Sun by Chance
<http://www.conknet.com/fiberstudio> fiberstudio@conknet.com



Kid 'N Ewe (and llamas too!)

Central Texas Wool Market
Blanco County Fairgrounds
Johnson City, Texas
November 13th, 14th and 15th

Spinning, Weaving, Knitting, Felting, Shearing Demos, Llama events, Sheep-To-Shawl and Handspun Skein Competitions, Auction, Lamb Dinner (with alternate vegetarian selection), Fashion Show, Dealers and all kinds of Livestock on display and for private Treaty sale.

For more information and tickets to the Dinner/Fashion Show please contact:
Mary Carol Buchholz, 6800 Creek Road, Dripping Springs, TX 78620
Ph 512-858-7920 or Tara Wheeler at 512-288-9845

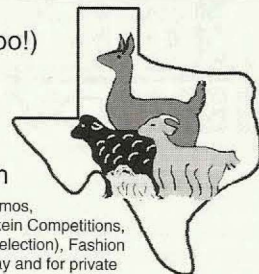

The Knits Resource Guide



www.paradisefibers.com
monthly drawings,
contests & specials!!
1-888-320-SPIN (7746)
New catalog \$2
spinning@colfax.com
701 Parvin Road
Colfax, WA 99111
1% of sales donated to charity

Books yarns and fine needle sets and circulars for lace knitting.

Lace weight wool	\$12.95 skein
Extra fine merino	\$15.95 skein
Merino & silk	\$19.95 skein
Spring stitch holder	\$ 3.95 each
	\$39.00 dozen

Please add \$5.50 shipping

THE LACE MAKER

4602 Mahoning Ave. NW, Ste. C
Warren, OH 44483
orders 800-747-2220
fax 330-847-8456



Joslyn's Fiber Farm
Hand-painted yarns in exciting colors at affordable prices. Mohair, merino, angora and even Samoyed dog yarns.

Wholesale accounts welcome!

Joslyn's Fiber Farm
Phone: 608-868-4070
E-mail: *jseefeld@inwave.com*
5738 East Klug Road
Milton, WI 53563



Qiviut



The world's most exceptional rare fiber.

The Musk Ox Company

Send \$4 and legal SASE for brochure and fiber samples
633 Fish Hatchery Road, Dept. I • Hamilton, MT 59840
Phone/Fax (406) 363-6818 <http://www.firesong.com/muskoxco.htm>



Earthsong Fibers

Mail-order source for knitters, spinners, weavers, dyers and other fiber artists

Yarns • Needles • Moth-proofing Herbs
Meadows Wool Wash • Yarn Sample Box • Essential Oils
Catalogue \$2.00 / with quarterly newsletter \$5.00

5115 Excelsior Blvd. #428 (Dept. IK)
Minneapolis, MN 55416
800-473-5350



General Bailey Homestead Farm

Featuring top quality products at reasonable prices.

SPINNING WHEELS: Majacraft, Jensen, Schacht, Ashford, Louet, and Columbine
Needles • Buttons • Books • Patterns
Yarn • Jewelry • Dyes • Exotics
Try our new super-size 13 1/2" x 18"
• **Knitter's Graph Paper—20 sheets \$8.50 ppd.**
New '98 Catalog \$2.00 (available 4-1-98)
340 Spier Falls Road • Greenfield Center, NY 12833-2005
(518) 893-2015 • VISA • MASTERCARD • DISCOVER

knitting NOW
A Newsletter for the Serious Knitter

In the FALL '98 ISSUE:
Sue Shabo's "Rainbow Pullover"
Betsy Newton's Patchwork Vest
PLUS Interviews, Articles & Reviews!

Send for Sample Issue: \$4.25 plus .75 postage to: **KNITTING NOW**
P.O. Box 543 • Norfolk • MA 02056 • 508-528-3289
Visit our Web Page at: www.knittingnow.com
e-mail: knitnow@aol.com



The SIMPLE MONTERA FELTED BOWLER, designed by Kim Atkins Degen, is the perfect perch for your favorite pin. It's quick to knit and fun to felt with Kim's expert instructions. Find it in the Fall '98 issue of Knitting NOW!

Garment Shaping
DesignaKnit
For Hand and Machine Knitters
Stitch Designer





Design Layout

Knitcraft Inc.
500 N Dodgion
Independence Mo 64050
816-461-1217
<http://www.knitcraft.com>

The Knits Resource Guide

Nordic Fiber Arts



POLARFEET

New! Socks with fleece lined soles
Knit warmth from soul to sole!!
Gray, Black, navy or Red \$27.50 ppd
4 Cutts Road Durham, NH 03824
603-868-1196



Addi, Austerman, Brittany,
Brown Sheep, Classic Elite,
Cleckheaton, Hayfield, Lane
Borgosesia, Patons, Plymouth,
Shepherd, Sirdar, Skacel,
Stahl, Tahki

Unusual Sweater and
Vest Kits
Space-dyed cottons
& chenilles

Visit our web site for complete list!

Elegant Stitches

14115 S. Dixie Hwy., Miami, FL 33176
(305) 232-4005 elegantst@aol.com
<http://members.aol.com/elegantst/index.html>



SCHOOL PRODUCTS CO., INC.

Come look us over for
**The Widest Selection of Designer
Yarns Anywhere!**

Looms, Brother Knitting Machines,
Accessories, Books, Videos and More!

Big Selection-Big Discounts

Mail Orders Available

e-mail: berta@schoolproducts.com <http://www.schoolproducts.com>

1201 Broadway, New York, NY 10001

212-679-3516

Pieces of String

Some call it string...
I call it sanity.
For you, it's a variety
of yarns up to
20%
off retail.

Trendsetters • Brown Sheep • Swedish Yarns • Dale of Norway
Berroco • Classic Elite • Renaissance and more
Catalog \$3.00 US, Refund with first order - Mail order only
810 22nd Avenue South, Moorhead, MN 56560 • 218-233-6670

Gemini Fibres

is your Canadian retail source for all your Knitting Supplies

* best book selection—all the latest titles *

* Videos to rent or purchase *

* Fibre Trend Patterns, Knitting Bracelets, McMorran Yarn Balance *

* Ontario's Dealer for Harrisville Designs Yarn *

* Hand-painted Unspun Scarf Kits & Hand-dyed Yarns *

* Canadian & Norwegian Pewter * Brittany Knitting Needles *

We also carry a full line of weaving and spinning supplies.

MAIL ORDERS WELCOME / PRICE LIST with SASE

Gemini Fibres

5062 Mount Albert Road East

Mount Albert, ON L0G 1M0 Toll Free: 1-800-564-9665

Tel: 905-473-1033 / Fax: 905-473-6544



The essentially sensual yarn makes
our exclusive vest kit a must have.
Knit side to side to show off this
micro fiber chenille, ribbon, and
novelties. Available in a variety of
luscious color ways.

"TOUCH ME"

\$5.00 sample card (applied to purchase)

The Weaver's Place, 75 Mellor Avenue
Catonsville, MD 21228

Interweave

Knits

Your Directory Ad Could Be Here!!!

This is the readership you have been looking for!

Call Knits Advertising Dept. (800) 272-2193
for more information

RAVELINGS

Robbie Fanning



Ich Bin Ein

Knitting Machine

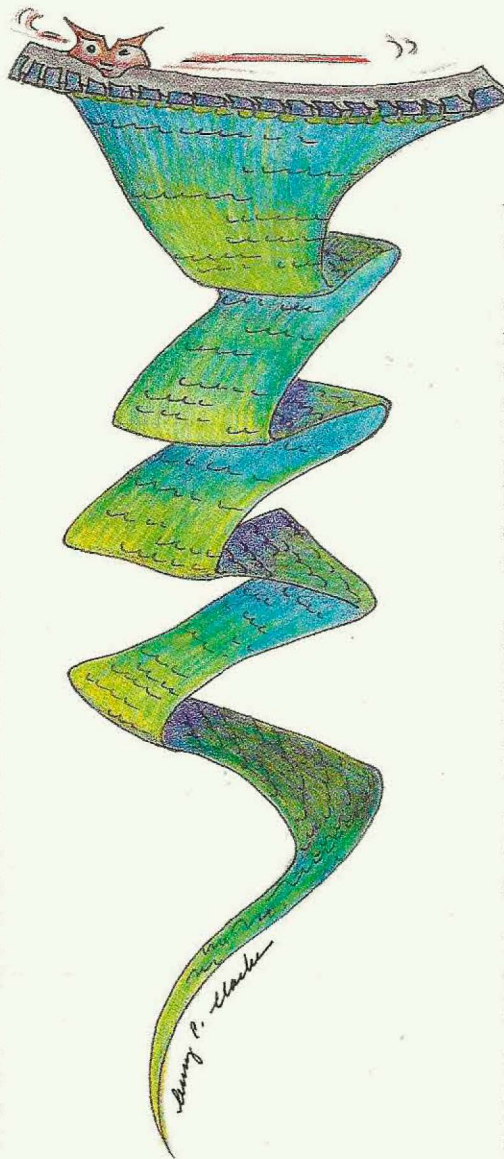

IN SEVENTH GRADE I decided to learn to knit. My mother took me to a department store and the saleswoman taught me to knit and purl. We bought yarn for a sweater and I plunged in. Our family traveled by car to visit relatives in the East that year and I remember obsessively knitting gray wool the entire trip.

When we had a flat tire, I sat on a suitcase beside the busy turnpike, knitting, purling, knitting. Assembling knitted pieces, however, did not appeal. The gray sweater parts languished in a drawer for years. Nevertheless, I would periodically knit again, usually after discovering an outstanding knitter's book, such as Elizabeth Zimmermann's *Knitting Without Tears* or Ida Riley Duncan's *Knit to Fit*. My knitting was always obsessive and unfinished.

One spat occurred when my daughter and I wanted to understand knitting. Interweave publisher Linda Ligon had told me that although she had handknit all her life, she didn't truly understand knitting until she worked her way through Jacqueline Fee's *The Sweater Workshop* (Interweave Press, 1983).

Kali and I began an oceanic, telephonic correspondence course (she's in England). We both knitted the odd-looking tube sampler from the book. Then Kali whipped out a sweater and her husband made a hat in the colors of Newcastle United; I made a hat and scarf (unfinished) and a sweater vest (unfinished). I got stuck because I started the sweater vest so long ago I can't remember what I was doing. It may be too tight and too short, perhaps because I worked the gauge sample on straight needles but the sweater vest on circular needles.

But I've discovered machine knitting. The technique appeals to me—and works—because I can adjust tension, knit a lot of yardage in a small amount of time, and actually finish what I make.

As a newcomer I found the machines weird and unfamiliar, like plastic aliens with keyboards and antennas. But they are easy to understand once you grasp the fact that instead of choosing two needles in a size appropriate to your yarn, as with handknitting, with machine knitting you choose an entire machine.

If you want to knit both fine baby items and heavy wool sweaters, you need two machines. I've been working on a baby lock Baby Knit with a Bond ribber, a Studio LK-150 mid-gauge, and an old Brother standard gauge. But now I understand that to build any pattern, hand-manipulating the same group of needles over and over is pointless when a computer can select the needles and do it effortlessly.

What I don't like about knitting machines is the space they take (I'm already full-up on sewing machines and sergers) and my uncertainty that a pattern shaped on the machine will fit. The beauty is that I have options other than all-machine-or-nothing. I can machine-knit some, hand-knit some, shape some parts, and cut-and-serge others. What I like most of all is that it's fast.

The test came one weekend when I machine knitted a v-neck vest for my husband in three evenings. During the first two evenings I made the front and back. On the third, I joined the seams and then handknitted the rib. A study in *Psychology Today* found that women have a stronger urge to finish tasks than many men have (called the Theory of Closure). For me, it's got to be fast or I don't finish.

Perhaps long ago I knitted so obsessively because I was afraid that if I paused, I would quit for good. Perhaps I wanted to be a knitting machine. ∞

Robbie Fanning is editor/publisher of The Creative Machine Newsletter. She recently cut the unfinished sweater vest up the middle, handknitted a band, and sewed it on.

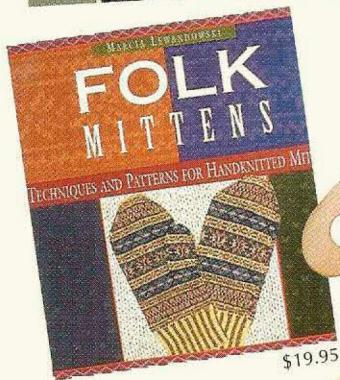
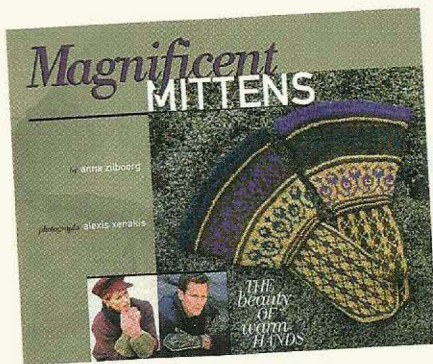

\$24.00/pr



\$24.00/pr



\$2.90



\$3.90

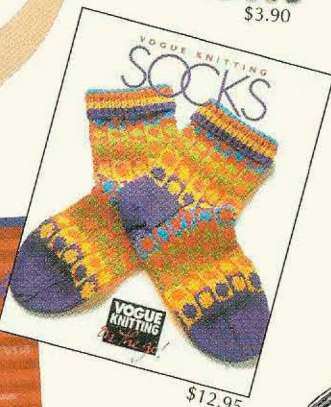

\$12.95

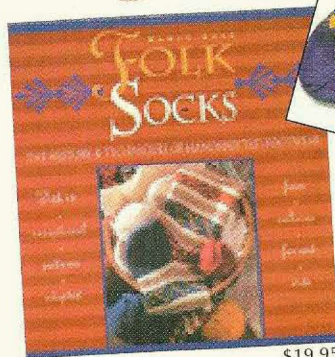

\$19.95



\$2.10

Plunge In

You'll love Halcyon Yarn!

Discover a world of color and texture...

Thick and thin, bright and bold, smooth and shiny, our natural fiber yarns are top quality. Open a Maine Collection sample box and find color cards for all our knitting yarns. *Special bulk pricing on yarn makes projects affordable!*

Expand your horizons...

Our shelves are stocked with hundreds of books and instructional videos. Call for our complete listing. *Purchase five or more books and save 15% – always!*

Use the right tools...

From knitting machines and knitting needles to notions, buttons and blockers, you'll find what you need. *Any questions? Our staff is here to help.*

Shop at home...

Our mail order service is friendly, convenient and affordable. Internet users will find us on the web at: www.halcyonyarn.com.

Call today for a free catalog!

1-800-341-0282



Halcyon Yarn

12 School Street • Bath, ME 04530

*Everybody knows
what it's like to cuddle
with a favorite blanket...*

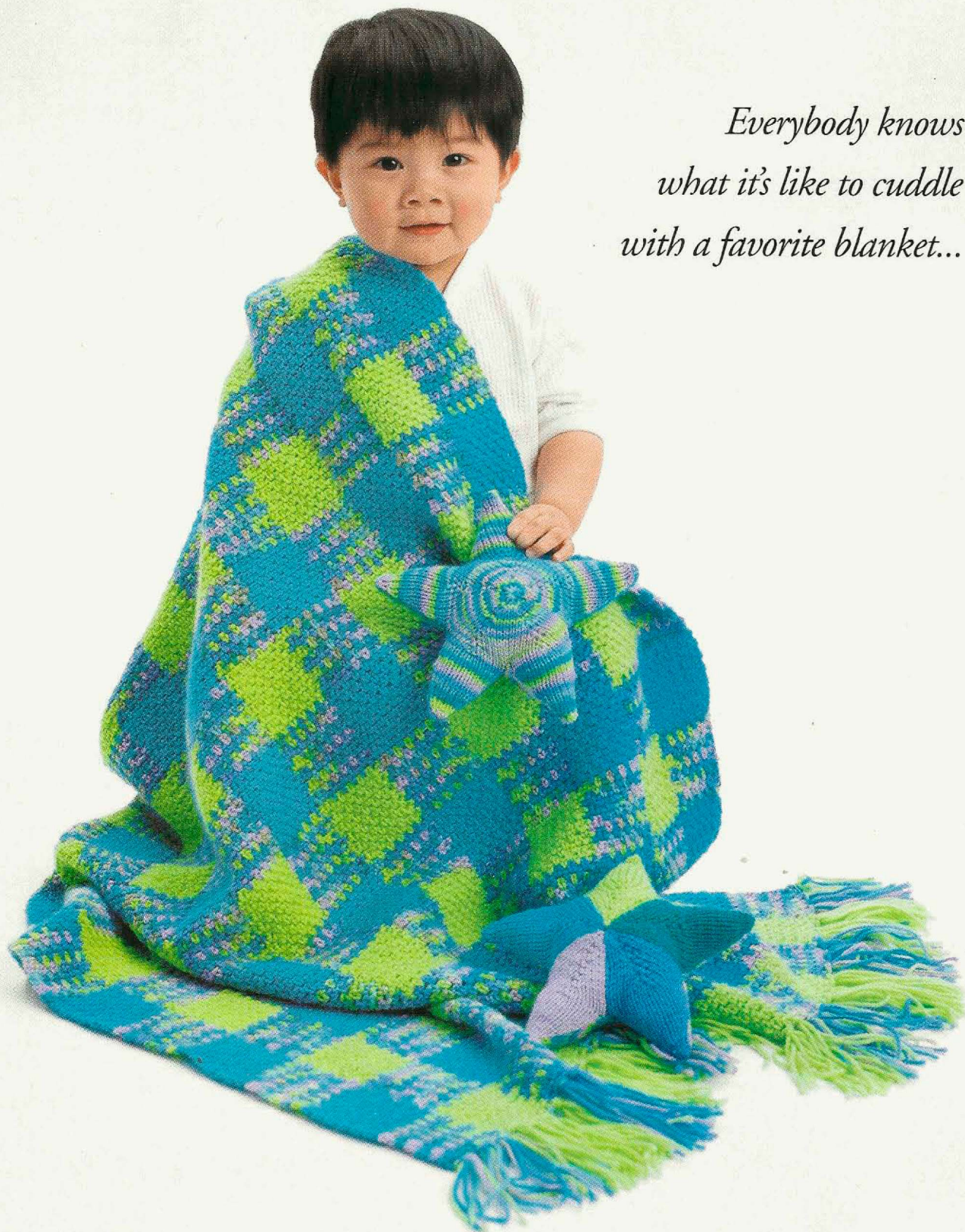

Look at Me!

PATONS NEW BABY SPORT YARN.
Perfect for your next project.

Free Offer: For your **FREE Baby's Little Blanket** crochet pattern, your **FREE Little Star Toy** knit pattern and a **LOOK AT ME!** color chart that is too cheeky to resist, send \$1.00 U.S. for shipping and handling today to: **LOOK AT ME!** P.O. Box 865, Stevens Point, WI 54481-0865.

 **Patons**
Patons Yarns...part of your life.
www.coatspatons.com